

Specification for

General Pipelining Designed to Operate at Pressures Greater than 7 Barg

GD/SP/P/10

Issue Date: July 2020

Version Control

Implementation date

November 2011

Review date

November 2016

Document owner

Engineering

Management approval

Head of Engineering

Disclaimer

This safety and engineering document is provided for use by Cadent Gas Limited and such of its contractors as are obliged by the terms and conditions of their contracts to comply with this document. Where this document is used by any other party it is the responsibility of that party to ensure that this document is correctly applied.

Mandatory & Non-Mandatory requirements:

In this document:

Shall: Indicates a mandatory requirement.

Should: Indicates best practice and is the preferred option. If an alternative method is used then a suitable and sufficient risk assessment must be completed to show that the alternative method delivers the same, or better, level of protection

The Company: Any reference in this document to 'the Company' shall be taken to mean Cadent Gas Limited.

Document History

Description	Date	Reference
First Published	October 1981	
Amendment No. 1 published	January 1982	
Amendment No. 2 published	August 1985	
Amendment No. 3 published	May 1988	
Amendment No. 4 published	July 1988	
Editorial update to reflect demerger	June 2001	
Editorial update to reflect merger	November 2002	
Editorial update to reflect Safety Case version 3 taking into account issues as detailed in the comments below. Additionally, compliance with mandatory terms along with the removal of no specific normative phrases.	September 2004	
Editorial update for National Grid re-branding	October 2005	
Editorial update and revision to account for changes in Edition 5 of IGEM/TD/1 and for current best working practices.	November 2001	
Updated to reflect business changes	July 2020	GD/SP/P/10

Comments and queries regarding the technical content of this document should be directed to:

July 2020

Cadent

Ashbrook Court

Prologis Park

Central Boulevard

Coventry

CV7 8PE

Copyright © 2020 Cadent Gas Limited - All Rights Reserved

Contents

Version Control	2
Document History	2
1. SCOPE	6
2. REFERENCES	6
3. DEFINITIONS	6
4. ROUTING CONSIDERATIONS	6
5. SAFETY AND ENVIRONMENT	7
6. CONSTRUCTION – GENERAL	7
7. ACCESS ROUTES TO SITE	8
8. PREPERATION OF THE WORKING WIDTH	8
9. PIPE STORAGE SITES	8
10. SETTING OUT	8
11. TEMPORARY FENCING	9
12. EMERGENCY REPAIR CREWS	9
13. HANDLING AND STORAGE OF PIPE	9
14. PIPE STRINGING AND FIELD BENDING	10
15. PIPE STRINGING AND FIELD BENDING	11
16. WELDING	11
17. FLANGED JOINTS	11
18. EXISTING SERVICES	11
19. RECORD OF CONDITION	12
20. SURFACE STRIPPING	12
21. EXCAVATION, BACKFILL, REINSTATEMENT, LANDSCAPING AND OTHER GEOTECHNICAL WORK	12
22. EXPLOSIVES	13
23. TRENCHLESS TECHNIQUES	13
24. LAND DRAINS	13
25. LOWERING OPERATIONS	14
26. CORROSION PROTECTION	14
27. CONCRETE COATING OF PIPES	15
28. CROSSINGS	15
29. WATER COURSES	16
30. CONSTRUCTION SLEEVES AND TUNNELS	16
31. TESTING	16
32. PIGGING	17

33. WORKS EXECUTED AFTER HYDROSTATIC PRESSURE TESTING 18

34. PIPELINE ROUTE MARKERS..... 18

35. LANDSCAPING 18

36. RECORDS..... 18

37. VARIANTS..... 19

APPENDIX A..... 46

References..... 46

APPENDIX B..... 49

Definitions 49

1. SCOPE

This Specification sets out the Company approved general requirements for site preparation, construction and testing of steel pipelines for the transmission of natural gas at pressures greater than 7 barg.

Pipeline construction shall be to IGEM/TD/1 Ed 5 for pipelines with a maximum operating pressure of greater than 16 barg or to the principles of IGEM/TD/3 Ed 4 for pipelines with a maximum operating pressure greater than 7 barg and up to and equal to 16 barg, as appropriate, and shall include all the requirements of this specification and GD/SP/TR18 "Specification for the Engineering of Pipelines and Installations".

2. REFERENCES

This Specification makes reference to the documents listed in Appendix A. Unless otherwise specified, the latest editions of the documents apply, including all addenda and revisions.

3. DEFINITIONS

The definitions applying to this Specification are listed in Appendix B.

4. ROUTING CONSIDERATIONS

Safety, environmental and technical evaluations are the major considerations when routing a pipeline.

4.1 The Routing Process

The routing process is a well defined process, which complies fully with the requirements of the Public Gas Transporters Pipeline Works (Environmental Effects) Regulations 1999, and is divided into three levels:

Level One – Feasibility Study
Level Two – Conceptual Design
Level Three – Detail Design

4.1.1 Level One - Feasibility Study

Consists of the gathering of information in the public domain covering issues associated with the natural, physical and built environment including main centres of population, Nature Conservation, Agriculture, Planning Policies, Archaeology, Aerial Photography Interpretation, Emissions, Landscape, Ecology, Topography, Socioeconomic, Soils and Land Use, Geotechnical information, and any other unique project specific issues, to enable a preferred route corridor option, with an approximate width of 1km., to be identified which minimises the environmental impact of the project, while taking account of all Safety, Health and technical construction issues. Reference shall be made to GD/SP/TR/21.

4.1.2 Level Two – Conceptual Design

Takes note of the information contained in the Feasibility Study and uses this information as the basis for refining the route corridor, using similar criteria as that adopted in the level one stage of the process, into a proposed pipeline route. At this stage of the process, on-site investigations should be undertaken to provide information for refining the route and, through the process of conducting an Environmental Impact Assessment (EIA), producing an Environmental Statement (ES) or Environmental Review, dependent upon the length and design pressure of the proposed

pipeline (see - Public Gas Transporters Pipeline Works (Environmental Effects) Regulations 1999). Reference shall be made to GD/SP/TR/22 and GD/SP/TR/23.

4.1.3 Level Three – Detail Design

Further refines the route, as more information in regard to environmental and technical issues is more clearly defined. All information gathered throughout this and the previous levels should be assessed for inclusion in the EIA process and the ES process. At this stage of the process the route shall be refined to avoid individual objects, for example trees, to produce the final constructible route. Reference shall be made to GD/SP/TR/24.

Reference shall also be made to Appendix D of GD/SP/TR/18 and IGEM/TD/1 Edition 5 for further information.

5. SAFETY AND ENVIRONMENT

Health, safety and environmental issues shall be addressed throughout the construction of the pipeline and associated pipework systems and installations. The Construction (Design and Management) Regulations 2007 [CDM] shall be complied with during the design and construction of any applicable pipeline or installation project. The Company's procedure for compliance with the regulations is detailed in NGUK/PM/SHE/81 'Safety Health and Environmental Management of Projects'.

Work on or near operational pipelines and installations (including new pipelines which have been tested, and de-commissioned pipelines) shall be carried out only in accordance with GD/PM/DP/1 and GD/SP/SSW/22.

Unexploded ordnance could be present along the pipeline route. Guidance related to such ordnance, including its disposal is provided in GD/PM/TR/39.

During the construction phase of the project, all undertakings and mitigation methods agreed within the ES should form part of the construction process. All environmental legislation and undertakings shall be fully implemented throughout the construction process and all environmental safeguards shall be put in place to minimise the effects of any pollution incidents should one take place during the construction phase or any other pre-cursory or subsequent phase of the project.

Silty water discharges are a pollution event and prosecutable under law. The silt has a detrimental environmental impact on the aquatic environment and affects both the flora and fauna. It is important that every effort is made to control silty water discharges and run off from construction projects and guidance on mitigation measures can be found in CIRIA C648. An Environmental Management Plan (EMP), in accordance with ISO 14001, shall be put in place, and environmental performance monitored throughout the whole design and construction process. Post construction, all undertakings/mitigation measures agreed in the ES shall be completed to the level agreed and to the satisfaction of the stakeholders with

6. CONSTRUCTION – GENERAL

The following shall be identified and agreed prior to work commencing:

- a) All necessary rights of way over the working width;
- b) Access to the Works along the route of the pipeline from any public highway crossing the same but excluding restricted roads to or from which access to the Works has been forbidden. 'NO ACCESS' notices shall be erected where access has been forbidden.
- c) Access to both sides of crossings with special requirements, either along the working width with turning areas adjacent to the crossing, or separately negotiated accesses specified in the particular specification.

- d) Storage (see clause 9) and site establishment areas for use on the Works.
- e) At least 7 working days notice to the relevant electricity company shall be given before starting work under overhead power lines with any equipment which could, when fully extended, exceed the safe working headroom.

The sites shall be managed in accordance with the Environmental Impact Statement and the Environmental Management Plan.

7. ACCESS ROUTES TO SITE

A Traffic Management Plan shall be prepared, and prior to work commencing shall be agreed with the Police, Local Authority and Landowner. A record of route conditions shall be produced and agreed prior to the commencement of construction.

8. PREPERATION OF THE WORKING WIDTH

Before commencing any work, the existence of any Notices or Orders intended for the preservation of any hedges, trees, buildings, or any feature within, or which may be affected by any of the works within any part of the working width, shall be established. These Notices and Orders shall be complied with at all times.

Before commencing any works, or removing any hedges, trees, buildings or any feature, a schedule of condition of all existing fences, hedges, trees, buildings, etc, shall be agreed.

The fencing of fields affected by the construction works shall remain secure and stock-proof as necessary throughout the duration of the works including when removing any fences, hedges, trees, buildings or any feature from within any part of the working width.

The working width shall be cleared of crops, brush, hedges, fences, non-saleable timber, tree roots and debris, and materials arising shall be disposed of accordingly. All stone walls shall be carefully dismantled by hand and stacked for re-use, stacking the topping stones separately.

Trees shall only be cut or removed with the written consent of the Company. All saleable timber shall remain the property of the timber owner.

9. PIPE STORAGE SITES

Pipe storage sites shall be identified and prepared in accordance with IGEM/TD/1 Ed 5 Supplement 1.

Pipe storage sites shall be reinstated to the condition which prevailed at the commencement of the works.

All surplus pipe shall be returned to a place nominated by the Company.

10. SETTING OUT

The Company shall be given not less than 24h notice of intention to set out the route of the pipeline or any installation. A report shall be made each day detailing the progress of setting out. Such labour, tools and surveying equipment as necessary shall be made available to the Company to check the setting out prior to carrying out any subsequent work.

During setting-out works a full topographical survey shall be undertaken to facilitate the reinstatement of the ground to the original ground profile.

11. TEMPORARY FENCING

Prior to the commencement of work, all parties shall agree the temporary fencing requirements with the occupier.

Temporary fences shall be erected to meet the reasonable requirements of the owner or occupier. Where stock-proof fences are required, they shall be in accordance with the following:

- a) Temporary stock-proof fences where horses are not present, under normal circumstances, shall comply with Figure 2.
- b) Temporary stock-proof fences for horses, under normal circumstances, shall comply with Figure 3.
- c) Gates or hurdles for temporary access shall be of steel-framed construction, complete with hinges and a locking hasp and generally to comply with Figure 4.

Before breaking into existing fences, walls and hedges, all temporary fencing shall be securely tied into existing fences, walls and hedges. Sections of strained wire fence shall be removed and restrained as shown in Figure 1.

All temporary fencing shall remain erected and maintained in good order during construction work and thereafter until reinstatement of land is complete and the Company has approved its removal, or it becomes the property of the landowner.

Gaps in fences, walls and hedges abutting on to the highway along the pipeline route shall be closed temporarily during construction by post and wire fences as shown in Figure 5. The fence shall also contain a suitable temporary gate of an approved design, generally to Figure 4, having a sufficient width to provide access for construction plant and opening away from the highway. The temporary gate shall be set back 15 m from the highway to assist with control of traffic. Particular works on the access shall be included as required by the Highways Authority.

In arable land, where no stock is present, fences as shown in Figure 6 shall be erected on both sides of the working width.

In areas where special disease precautions are in force, the requirements of the Department of the Environment, Food and Rural Affairs shall be complied with.

Proper and adequate facilities for passage of persons, stock and agricultural equipment across the working width at all stages of construction shall be provided wherever an access is obstructed, or where required by the Company (see Figures 7 and 8).

The reuse of fencing materials on other farmland is prohibited in order to avoid the potential for transfer of disease. Consideration shall be given to reuse by that land owner or by the recycling of the fencing materials.

12. EMERGENCY REPAIR CREWS

An emergency crew and an environmental emergency crew shall be made available 24h a day at all times during period of the works and shall include experienced and named personnel.

13. HANDLING AND STORAGE OF PIPE

13.1 General

All materials shall be subjected to a stores documentation procedure to provide a permanent record of all receipts and issues.

The storage, handling and transportation of pipe and fittings shall be in accordance with IGEM/TD/1 Edition 5 supplement 1.

Where pipes are cut, all pieces shall be clearly marked using an indelible pen, with the original pipe identification. Re-bevelling of surplus pipe shall be carried out as directed by the Company. Removal of surplus pipes and other materials from the storage sites shall only be carried out on the instructions of the Company.

13.2 Materials supplied by the Company

Materials supplied by the Company shall be accepted by the Contractor, who shall be responsible for their security, handling, storage and insurance. The materials shall be stored in a manner to facilitate identification. Materials of different specification and source shall be stored separately.

The Contractor and the Company together shall examine materials supplied by the Company, at the place of acceptance. The Contractor shall, within 24h of such examination, provide the Company with two copies of a receipt on which shall be shown the type and quantity of materials and the extent of any damage. Any pipes accepted which have damaged coatings shall be repaired to the satisfaction of the Company.

Materials supplied by the Company which are accepted by the Contractor and not incorporated in the Works, and in the opinion of the Company are unsuitable for re-use resulting from the Contractor's neglect, shall not be returned to the Company. Such materials shall be reimbursed at replacement cost.

13.3 Materials supplied by the Contractor

Apart from the materials supplied by the Company, the Contractor shall provide all materials as necessary to complete the Works. Within thirty days of the award of the Contract, the Contractor shall produce to the Company evidence of ordering or intent to purchase any Contractor supplied material(s). The evidence produced by the Contractor shall satisfy the Company that no delay is likely to occur due to lack of availability of Contractor supplied materials.

The Contractor shall provide documentation and certification to cover any items of material supplied by him prior to inclusion in the Permanent Works, sufficient to meet the requirements of GD/PL/RE/1 and a copy of this documentation shall be provided to the Company prior to use.

14. PIPE STRINGING AND FIELD BENDING

Pipes shall be offloaded and strung along the route of the pipeline. At agreed crossing points, gaps shall be left in the stringing of the pipes to permit the passage of the owners or occupier's equipment and/or livestock across the working width.

Pipes shall not be placed on the ground, but shall be placed on timbers with wedges, in accordance with IGEM/TD/1 Edition 5 supplement 1.

The inside of all pipes and fittings, and the bores of all valves, shall be examined for cleanliness prior to lining up, and any extraneous matter shall be removed by an approved method to the satisfaction of the Company.

Protection of all pipe and pup ends shall be retained in position for as long as practicable before incorporation in the works.

The pipeline shall at all times be kept free of extraneous material, and, when work is not in progress, the open ends of the pipeline shall be securely capped with an approved cap fixed to resist unauthorized removal.

When required, sufficient coating shall be carefully removed to allow for cutting pipes and subsequent welding in accordance with GD/SP/P/2, and for testing in accordance with GD/SP/NDT/2

The minimum length of matching pieces (pups) shall be in accordance with GD/SP/F/6.

When field bending is required, the radius of bending shall not be less than that shown in Figure 9a. The bend shall be performed on a suitable machine, using an internal mandrel unless otherwise agreed by the Company, to provide a smooth profile, without wrinkling, and with not

less than 1.25m of straight pipe before and after the bend. For longitudinal welded pipes the pipe shall be positioned in the bending machine so that the longitudinal weld is coincident with the neutral axis of the bend to be formed (see Figure 9b). Factory produced bends shall be used if a smaller bend radius is required.

Before construction, a bending procedure qualification trial shall be carried out, using the bending machine to be used on the project, and pipe with the largest ratio of diameter to wall thickness as used on the project. The bending angle at each bending step should be clearly identified. The bending procedure qualification shall be considered satisfactory if a bend with a smooth profile, free from wrinkles, and meeting the requirements of this specification, can be produced consistently.

After cold bending, any damaged coating shall be made good in accordance with clause 27.

Before they are incorporated into the pipeline, all bends shall be gauged for ovality in the presence of the Company, using a device with an aluminium sizing plate having a diameter in accordance with Table 1.

TABLE 1 - Sizing plate diameters for pigging and other operations

Pipeline nominal size mm	Sizing plate diameter
Less than 600	Actual minimum bore of pipeline less 25 mm
600 and greater	95% of actual minimum bore of pipeline

15. PIPE STRINGING AND FIELD BENDING

Minor repairs to pipe and fittings are only allowed with the prior written consent of the Company. Where the remaining wall thickness after repair would be outside the dimensional tolerances allowed in the relevant material specification, then the damaged pipe or fitting shall be cut out and replaced.

16. WELDING

All welded joints shall be made and inspected in accordance with GD/SP/P/2, GD/SP/P/8 and GD/SP/NDT/2.

17. FLANGED JOINTS

Bolts shall be tightened in such a manner as to ensure that an adequate and even pressure is exerted around the circumference of the joint at all times, in accordance with GD/SP/E/55.

18. EXISTING SERVICES

All underground services likely to be affected by the work shall be located prior to any excavation, in conjunction with the owner of the services in question. All such services shall be included in the "as-laid" records.

Care shall be taken to prevent damage to, or interference with, the proper functioning of all underground services. Services shall be carefully located using hand excavation and marked and

protected prior to mechanical excavation. Reference shall be made to HS(G)47 Avoiding Damage from Underground Services.

Work in proximity to existing gas mains and pipelines shall be in accordance with HS(G)47, GD/PM/DP/1 and GD/SP/SSW/22.

Care shall also be taken when working in the vicinity of overhead electric cable and reference should be made to GS6 Avoidance of Danger from Overhead electric Powerlines.

19. RECORD OF CONDITION

Prior to the commencement of any work on site, a visit shall be arranged with all relevant parties, including the Highway Authority or Highway Managers, the Company, and the Contractor. They shall together note all damage in the proposed working area. In these areas, photographs shall be used as a permanent record of the pre-contract state.

A Record of Condition shall also be taken for pipelining and land drainage works in private land in conjunction with the landowner including but not limited to land use, land condition, boundary condition, ditch condition. Header land drains shall also be recorded and could be photographed where appropriate.

20. SURFACE STRIPPING

Stripped topsoil, to a width and depth as instructed by the Company, shall be kept separate and stacked on one side of the working width. It shall be kept free from the passage of vehicles and plant. Topsoil of a special nature such as soil associated with hedge-banks or road verges of an environmentally sensitive nature should be stored separately. Road metal or other surface materials and hard core shall be kept separate from other excavated material.

The width of topsoil to be stripped should generally be that required to contain the trench, the excavation plant, the temporary running track and the width required for stacking the subsoil, or as otherwise instructed by the Company.

21. EXCAVATION, BACKFILL, REINSTATEMENT, LANDSCAPING AND OTHER GEOTECHNICAL WORK

Excavation, backfill, reinstatement and other geotechnical work shall be in accordance with GD/SP/CE/2.

All work within public highways shall be in accordance with the New Roads and Streetworks Act.

Reinstatement of public highways shall be in accordance with HAUC Specification for the reinstatement of Openings in Highways

The pipeline shall be laid to contour at a depth of cover of not less than 1.2 m from the original surface to the top of the pipe, except when specifically directed otherwise by the Company. The trench shall be excavated so that pipes are evenly bedded throughout their length. Minor variations in contour shall be excavated in order to minimize field bending.

Where it is found necessary to increase the depth of a pipe, the pipe shall be removed from the trench prior to further excavation.

Before commencing any excavation in running sand, peat bog or rock, the proposed excavation method shall be stated.

the Company shall have the opportunity to check the line and level of the pipe prior to bedding and backfill.

Where the excavation is in rock or sharp edged stone, there shall be a bed of earth, sand or other suitable material placed beneath the pipe to a minimum depth of 150 mm.

Backfill should follow soon after the lowering-in of the pipe. Fine-grade material free from sharp edged stones shall be filled and compacted carefully around the sides of the pipe and to a minimum consolidated height of 150 mm above the pipe. Fine grade material is defined as sand aggregate passing a 5mm test sieve. Backfill shall be undertaken in consolidated layers no greater than 300 mm in depth.

Any damage caused during the construction of the pipeline to any permanent fences, hedges or walls shall be made good.

Where hedges are to be replaced, container grown hedging material shall be planted in accordance with GD/SP/LAN/1, or other specification acceptable to the landowner, and protected by fences as shown in Figure 10.

Permanent fences across the pipeline shall be of the same type and design as the existing fence.

Where stone walls have to be replaced, only stone previously dismantled from the wall, or if necessary matching stone from an approved source, shall be used. These walls shall be constructed over the pipeline trench supported on a concrete foundation.

Where specified, a stile or gate shall be included in any fence or wall,

Figures 10 to 15 inclusive show typical details of fencing and gates for various purposes.

22. EXPLOSIVES

Written application(s) to the Company shall be made for permission to undertake blasting operations 21 days prior to the requirement to blast at any location. Permission to undertake blasting shall be given by the Company in writing.

Further information on blasting is contained in GD/SP/CE/2 and GD/SP/SSW/22.

23. TRENCHLESS TECHNIQUES

Horizontal Directional Drilling, thrusting, auger boring, pipe jacking or any other method employed to form a tunnel or heading, shall not be commenced until all such proposals have been accepted by the Company.

24. LAND DRAINS

All land drainage work shall be in accordance with LDCA (Land Drainage Contractors Association) Technical Note for Drainage Schemes.

A topographical survey shall be undertaken for the design and installation of appropriate land drainage across the working width, and such drainage installed during the construction stage.

Damage or disturbance to land drains outside the trench width shall be kept to a minimum. Immediately any land drain is located, its position shall be prominently marked by pegs 40 mm x 40 mm in section and one metre long, painted white and placed at each side of the working width. These pegs shall be maintained until the drain has been reinstated, and reinstatement has been accepted by the Company.

Where appropriate, following discussion and acceptance of the drainage design by the landowner/occupier and the Company, land drains shall be replaced over the working width of the pipeline. Unless otherwise directed by the Company, crossing of the pipeline trench by land drains shall be kept to the absolute minimum whilst still providing an adequate drainage system. Wherever possible, the drainage system should be designed to run in parallel with the pipeline

trench and connected to an adequate outfall drain on a field by field basis. Cross connecting of existing land drains over the pipeline trench should be strongly resisted wherever practicable. Where circumstances dictate that a land drain should cross the pipeline trench, the trench shall be backfilled to provide a good firm bed. Before cross connecting the make-up piece to connect to an existing drain, the existing drains being connected shall be cleared to the edge of the working width on each side.

When replacement of a land drainage system has been completed, backfilling shall not begin until instructed by the Company. The Company shall afford the owner or occupier of the land a reasonable opportunity, not exceeding two working days, for inspection before backfilling is begun, and the work shall be programmed accordingly.

Care should be taken to avoid damage to the drains during backfilling or reinstatement. Any damage that is caused shall be made good.

Header drains, or cut-off headers, shall be installed at the direction of the Company following agreement by the landowner/occupier. Post construction drainage shall be installed to reinstate the drainage system.

Generally, all land drains shall be backfilled to surround the drainage pipe with 20-40 mm washed gravel or similar approved porous filling up to 300 mm of the ground surface level unless otherwise specified by the Company.

25. LOWERING OPERATIONS

No lowering operation shall be undertaken except in the presence of the Company, who shall be given at least 24 h notice of when any lowering operation is planned to take place.

Lowering into the trench shall be carried out by a method to be agreed between all parties, including the Contractor and the Company, prior to the commencement of such operations, and shall take place as soon as possible after the trench has been excavated. During this operation, special care shall be taken to ensure that the pipe coating is not damaged and that the pipe is not laid in a stressed condition. Any damage to the pipe coating indicated by holiday detection during the lowering operation shall be repaired before lowering is completed. When using coatings other than FBE, consideration shall be given to restricting lowering operations during periods of high or low ambient temperature.

26. CORROSION PROTECTION

26.1 General

Only authorised competent personnel shall be used for coating, wrapping and painting work

Pipe cleaning or coating or wrapping operations shall not normally be permitted in wet weather or where other prevailing conditions make the process unsuitable. Where it is necessary, and with the approval of the Company, these operations may be continued with the aid of protective covers and/or additional preparatory measures.

Provision shall be made to prevent any risk of contamination of water courses with materials associated with the corrosion protection process.

26.2 Protection methods

Where externally coated pipe is supplied, the coating shall be in accordance with specification GD/SP/CW/6. Fittings should be supplied painted in accordance with GD/SP/PA/10 for above ground use or coated in accordance with GD/SP/CW/6 for in-ground use.

Pipe and fittings not coated in accordance with the above specifications shall be treated and prepared in accordance with the Company's instructions to render them suitable for painting (above ground) or coating (below ground).

Field applied coatings and all surface repairs to existing coatings shall be carried out in accordance with the relevant Supplement to GD/SP/CW/5.

All above ground pipes, valves and fittings shall be prepared, painted and tested in accordance with GD/SP/PA/10, with paint supplied to GD/SP/PA/9.

Materials and processes other than those covered in GD/SP/CW/5 and its Supplements, and GD/SP/CW/6, shall only be used if specified by the Company. In such cases the Company shall provide full details relating to the application of such materials.

The method of removal of coatings shall generally be in accordance with GD/SP/CW/5, Supplement CA/13. The method adopted shall, in any event, be such as to cause no damage to the metal surface of the pipe or fitting.

Cathodic protection shall be applied in accordance with GD/PL/ECP/1 and GD/PM/ECP/2, together with the relevant detailed drawings and/or specifications. Temporary cathodic protection for pipeline sections shall be applied and maintained during construction prior to the commissioning of the full cathodic protection on completion of the works.

Particular care shall be taken to ensure there is no damage arising to the coating from the use of trenchless techniques. The integrity of the coating at such locations shall be demonstrated to the satisfaction of the Company.

26.3 Inspection

On completion of the on-site coating, but before commencement of the ditching operation, the coating shall be inspected by the Main Works Contractor and witnessed by the Company. All necessary repairs shall be carried out. The preferred method of holiday detection is by the use of copper hand-held brushes. The use of any other techniques will not be permitted without first obtaining the permission of the Company. Holiday detection shall only be carried out in climatic conditions accepted as satisfactory by the Company.

Any defect in the coating shall be made good, and these repairs shall be inspected by the Company before lowering of the pipe into the trench.

the Company may at any time remove or cause to be removed for the purpose of inspection, any paint or coating on the pipeline, and any such removed protection shall be made good.

Following completion of construction and consolidation of backfill, and before commissioning a coating defect survey shall be carried out in accordance with the requirements of GD/PL/ECP/1 and GD/PM/ECP/2, and the requirements of GD/SP/ECP/4, GD/SP/ECP/5 and GD/SP/ECP/6. Coating faults indicated by the survey shall be exposed and repaired in a manner acceptable to the Company.

Where trenchless techniques are employed a current drain test shall be carried out in accordance with GD/PM/ECP/2.

27. CONCRETE COATING OF PIPES

For pipes specified as requiring concrete coating for buoyancy, security or thrust boring applications, the Contractor shall concrete coat the pipeline in accordance with the requirements of GD/SP/CW/9: Parts 1, 2 or 3.

28. CROSSINGS

For pipelines with operating pressure in excess of 16 barg, thicker wall pipe in accordance with IGEM/TD 1 Edition 5 clause 6.10.2. shall be used at road, rail, river and other designated crossings and proximity situations. Thicker wall pipe or increased depth of cover should also be considered for crossings of ditches and other minor water courses and crossings, to obviate the need for impact protection slabs as far as possible (see clause 28.1).

The transition between proximity pipe and standard line pipe shall be in accordance with GD/SP/P/16 as appropriate.

Where impact protection slabs are considered necessary they shall be provided in accordance with IGEM/TD/1 Edition 5 clause 6.9 and designed and constructed to GD/SP/CE12. Protection slabs may also be required at crossings of services, or to bear construction traffic, and should be designed and constructed to GD/SP/CE/12.

The use of trenchless techniques (Horizontal Directional Drilling, pipe jacking, thrust bores etc) should be considered at designated crossings.

Where open-cut methods are employed for crossings, warning marker tape should be placed between the backfill and sub-base layers in road or footpath constructions, or 250 mm above the crown of the main or sleeve in open ground.

For typical crossing details refer to figures 16 to 24 of this specification.

29. WATER COURSES

Where a water course, trench, ditch or culvert is under the control of any Statutory Authority, the design of the crossing and protection works shall be in accordance with their requirements.

Where it is not under the control of any Statutory Authority, the pipeline shall be protected by the use of thicker wall pipe, increased depth, or an impact protection slab (see also clause 28).

Unless otherwise stated, the pipeline shall be located at such a depth as to give a depth of cover of not less than 1.7 m from the bottom of the water course, after the removal of any silting, to the top of the pipe, and to maintain a depth of cover of not less than 1.2 m in the adjoining fields.

All water courses, trenches, ditches or culverts shall be maintained in effective working condition over their full working width for the duration of the Works and shall be restored to a condition at least as good as before the commencement of the Works.

Where pipe floatation is a risk, mitigation measures shall be undertaken.

For typical water course crossing details refer to Figures 22-24.

30. CONSTRUCTION SLEEVES AND TUNNELS

Refer to section 7.22 of IGEM/TD/1 Edition 5 for distinction between sleeves and tunnels.

The use of sleeves should be avoided wherever possible. However, in certain circumstances, it may be necessary to install a sleeve to facilitate construction of the carrier pipe.

Sleeves shall be constructed of concrete and in accordance with IGEM/TD/1 Edition 5 clause 7.22.

The annulus shall be cleared of silt or other debris before sealing the ends. The annulus between the sleeve and the carrier pipe shall be completely filled with grout or other approved material following the testing of the carrier pipe, in accordance with IGEM/TD/1 Edition 5 clause 7.22.5.

Concrete sleeves should be designed for the fill and surcharge loading likely to be applied and also be suitable for the bedding material. They should also meet the requirements of BS 5911.

31. TESTING

31.1 General

The testing of pipelines and associated installations shall be carried out in accordance with GD/PM/PT/1 and either IGEM/TD/1 Edition 5 section 8 or IGEM/TD/3 Edition 4 section 7 as appropriate.

31.2 Pre-tested pipe

The use of pre-tested pipe should be kept to a minimum and restricted to situations where a test failure would have significant Health, Safety or Environmental impact. A risk assessment shall be carried in such cases out to determine if pre-tested pipe is necessary.

Where pre-installation tested pipe is to be used, the Company shall be advised of the amount of pipe to be pretested and the intended testing method.

Tie-ins should usually be executed using the overlap technique. Where this is not possible, pre-tested pipe shall be used, with untested "golden" welds limited to a maximum of two per tie-in fabrication.

31.3 Failure repair

In the event of any pipeline test failure, repair shall be carried out as detailed in IGEM/TD/1 Edition 5 clause 8.12.

31.4 Test end removal

Test end manifolds should not be cut off until the pipeline is about to be tied in to the adjacent pipework. If it is necessary to cut off a test end other than immediately prior to tie-in, the pipeline end shall be positively sealed in a manner acceptable to Na the Company.

All test ends shall be in accordance with GD/SP/E/56, clearly identified, and a register maintained to record their operational history.

32. PIGGING

Pigging shall only be carried out if the associated pig traps and test ends are designed specifically for the purpose of running pigs as outlined below and to withstand acceptable end loading as may be experienced by debris being brought in ahead of the pig.

Pigging requirements shall be as follows:

- A series of cleaning/swabbing pigs shall be used to clear the pipeline or pipeline section from any obstruction and construction debris prior to gauging.
- A gauging pig shall be used on each test section prior to pressure testing.
- The sizing of the gauge plate and material shall be in accordance with Section 14 and Table 1.
- Pressure testing pigging operations shall be carried out in accordance with IGEM/TD/1 Ed 5, Appendix 6
- A gauging pig shall be run through the completed pipeline. Where the pipeline has been tested in multiple test sections due to topography or water supplies, the run shall follow the joining of all test sections into a single pipeline.
- A geometric pig shall then be passed through the pipeline to prove the bore. This tool shall be capable of discriminating between ovality and denting for reporting purposes.

Following the geometric pig run, all reductions equal to or greater than 2.5% of the nominal internal diameter and any dents associated with welds shall be investigated, assessed and where required by the Company remedial action taken. These should be detailed in a report submitted to the Company for review a minimum of 10 days before commissioning. Reductions above 0.5% but below 2.5% of the nominal internal diameter shall be recorded and included in the report.

33. WORKS EXECUTED AFTER HYDROSTATIC PRESSURE TESTING

Works requiring the use of plant shall be completed prior to the hydrostatic pressure testing of respective sections of the pipeline unless the timing of such works is previously agreed by the Company.

Where any works are to be carried out after the hydrostatic pressure testing of the pipeline (e.g. ground reinstatement or drainage works), the works shall be managed using the Company permitry in compliance with management procedure GDN/PM/SCO/1 as appropriate. Only competent persons approved under GDN/PM/SCO/1 as appropriate will be allowed to supervise the works. Works shall be carried out in accordance with GD/PM/DP1 and GD/SP/SSW22.

Where it is necessary to continue to have access along the working width for the working or movement of plant, an approved temporary fence shall be erected to indicate the prohibited section of the working width. The temporary fence shall be positioned clear of the pipeline by not less than three metres, or as agreed with the Company. At least two working days notice shall be given to work or to move vehicles within a restricted access location so that the Company may arrange for the necessary supervision.

Should it be necessary to move plant across a section of the pipeline which has already been tested, this shall only be done with the approval of the Company. Adequate protection of the pipeline shall be provided. Failure to comply with this clause shall render the section of the pipeline affected subject to a re-test.

At least two working days notice shall be given to work or to move vehicles within a restricted access location so that the Company may arrange for the necessary supervision.

Should it be necessary to move plant across a section of the pipeline which has already been tested, this shall only be done with the approval of the Company. Adequate protection of the pipeline shall be provided. Failure to comply with this clause shall render the section of the pipeline affected subject to a re-test.

34. PIPELINE ROUTE MARKERS

Route markers shall be designed and installed in accordance with GD/SP/TR/29 and GD/PM/TR/28.

35. LANDSCAPING

Prior to landscaping, all contouring and top soiling shall have been completed to the satisfaction of the Company.

The landscaping shall be carried out in accordance with GD/SP/LAN/1 and GD/PM/LAN/2.

36. RECORDS

An FR2 form shall be completed on the commissioning, diversion or modification of any steel pipeline with a design pressure of 7 barg or above and returned to the nominated User of the pressure system within UK Distribution or UK Transmission, as appropriate, in order to update the UKOPA Pipeline Fault Database. The FR2 form can be found on the company Infonetuk from a link within GD/PM/PSR/4. This link is repeated below:

https://cadentgasltd.sharepoint.com/:w:/r/sites/SnED/_layouts/15/Doc.aspx?sourcedoc=%7B12F89C65-0E4B-4327-A3E8-14C39A69723D%7D&file=FR2%20Pipeline%20Transmission%20Faults%20%E2%80%93%20Pipeline%20Input%20Datashet%202019.docx&action=default&mobileredirect=true&DefaultItemOpen=1

FR2 forms are sent to:

Cadent
Network Strategy
Brick Kiln Street
Hinckley
Leicestershire,
LE10 0NA

37. VARIANTS

Where a Deviation to this specification is proposed it shall be subject to the requirements of GD/PM/GR/2 following discussion with the Company.

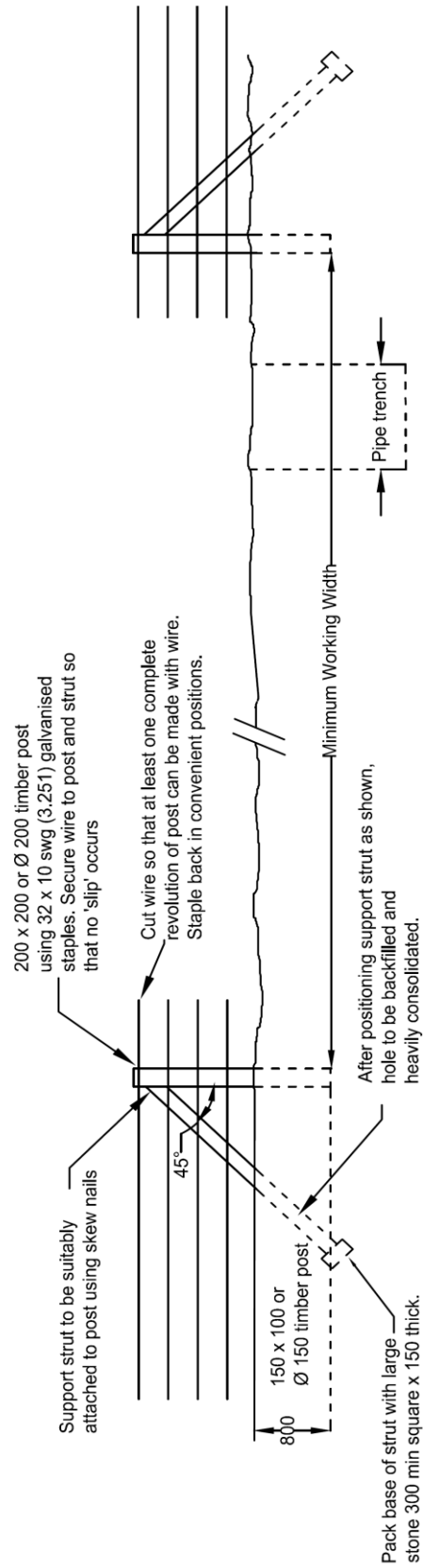

NOTES

1. All dimensions in mm.
2. Support Strut to be fitted and wire secured to the post prior to cutting and wrapping the wire around the post.

Figure 1 - Method of removal and reinstatement of section of strained wire fence

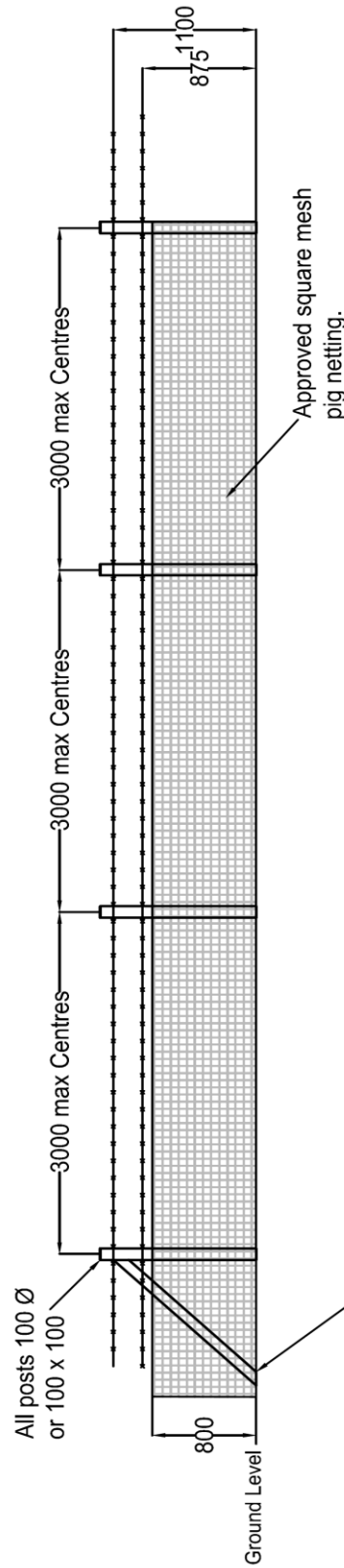

NOTES

Struts $\text{Ø}75$ min. at mid length or (85 x 85)
 Straining posts and struts to be installed at all corners, changes in direction and acute variations in level, and at 50 metre max centres on straight.

1. All dimensions in mm unless stated otherwise.
2. In the case of notifiable diseases all materials and tools shall be sprayed with disinfectant solution in the recommended strength before moving on to land and commencing erection of fencing.
3. Line wire to be to BS4102, and Galvanised to BS EN 102044-2 : 2001
4. Gauge of wire to be :
 - a) High tensile, 2 ply, 4 point barbs, 14 swg (2.032), or
 - b) Mild steel, 2 ply, N-point barbs, 12 swg (2.64).

Figure 2 - Stockproof right of way fencing

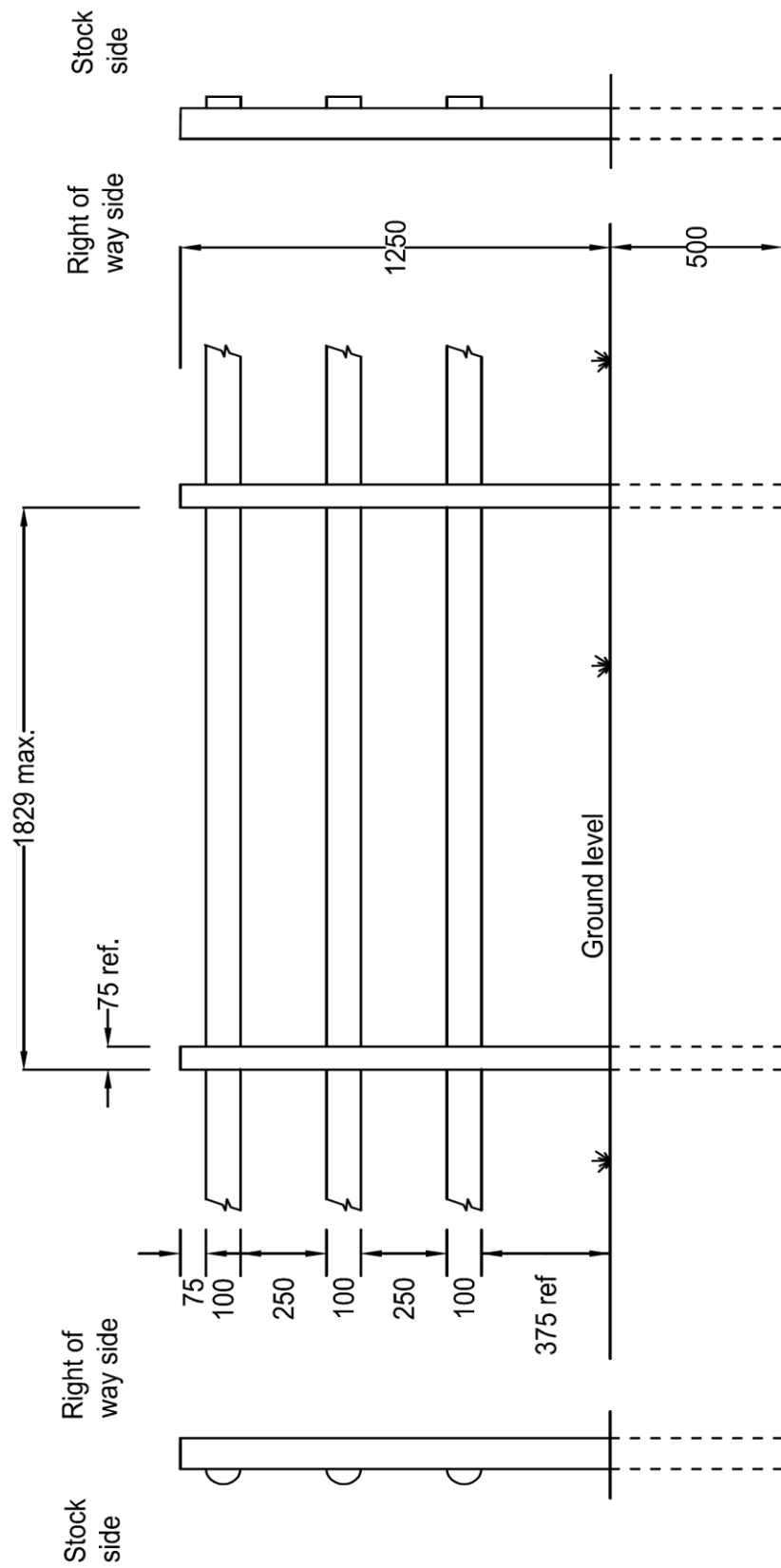

NOTES

1. All dimensions in mm.
2. Materials:
 - a) Rails: Untreated 100 x 38 sawn timber, or untreated 100 half round timber.
 - b) Posts: Untreated 100 x 75 timber, maximum spacing as shown.
3. In special circumstances, design may be altered to suit landowners requirements.

Figure 3 - Stockproof fencing for horses

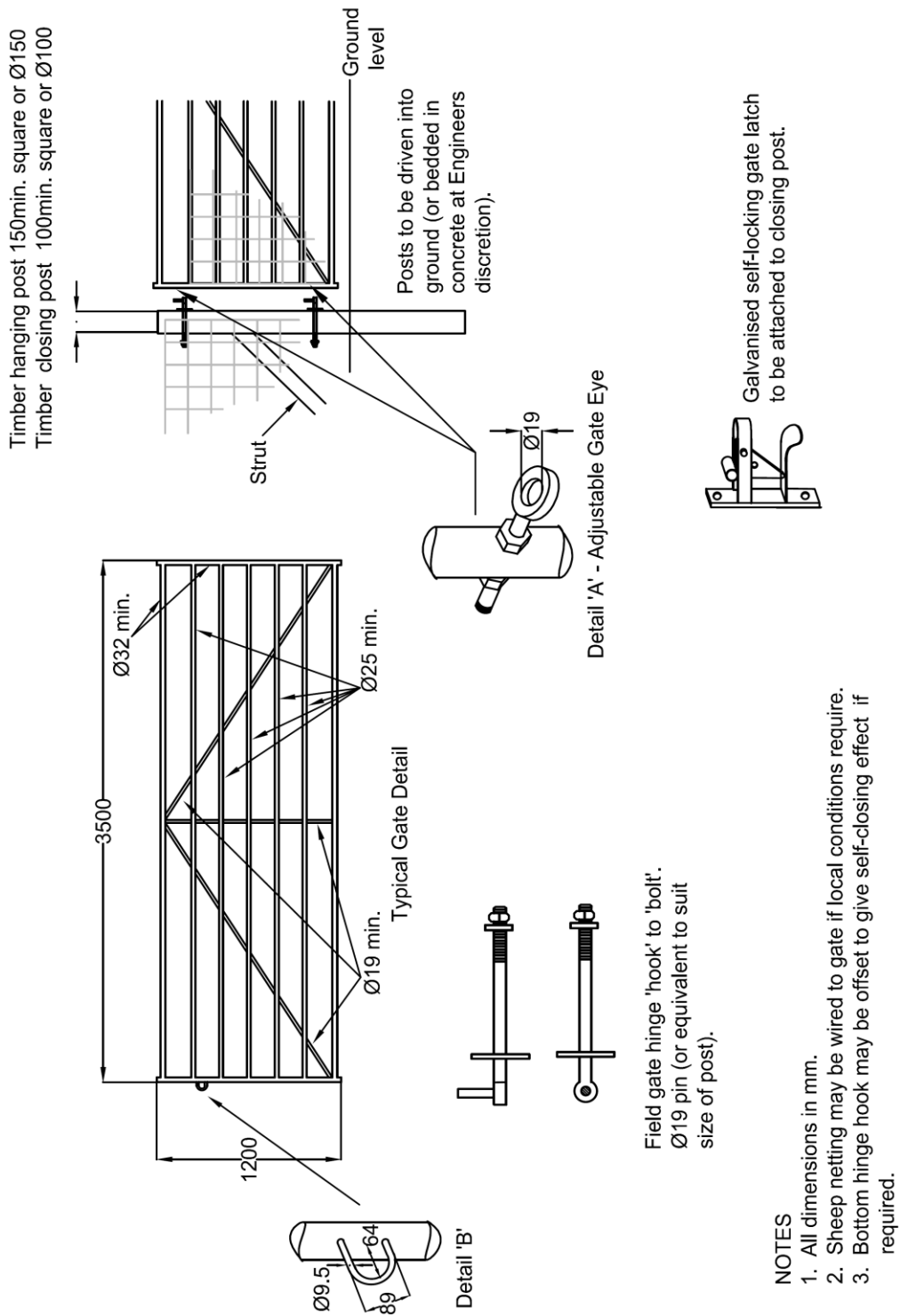
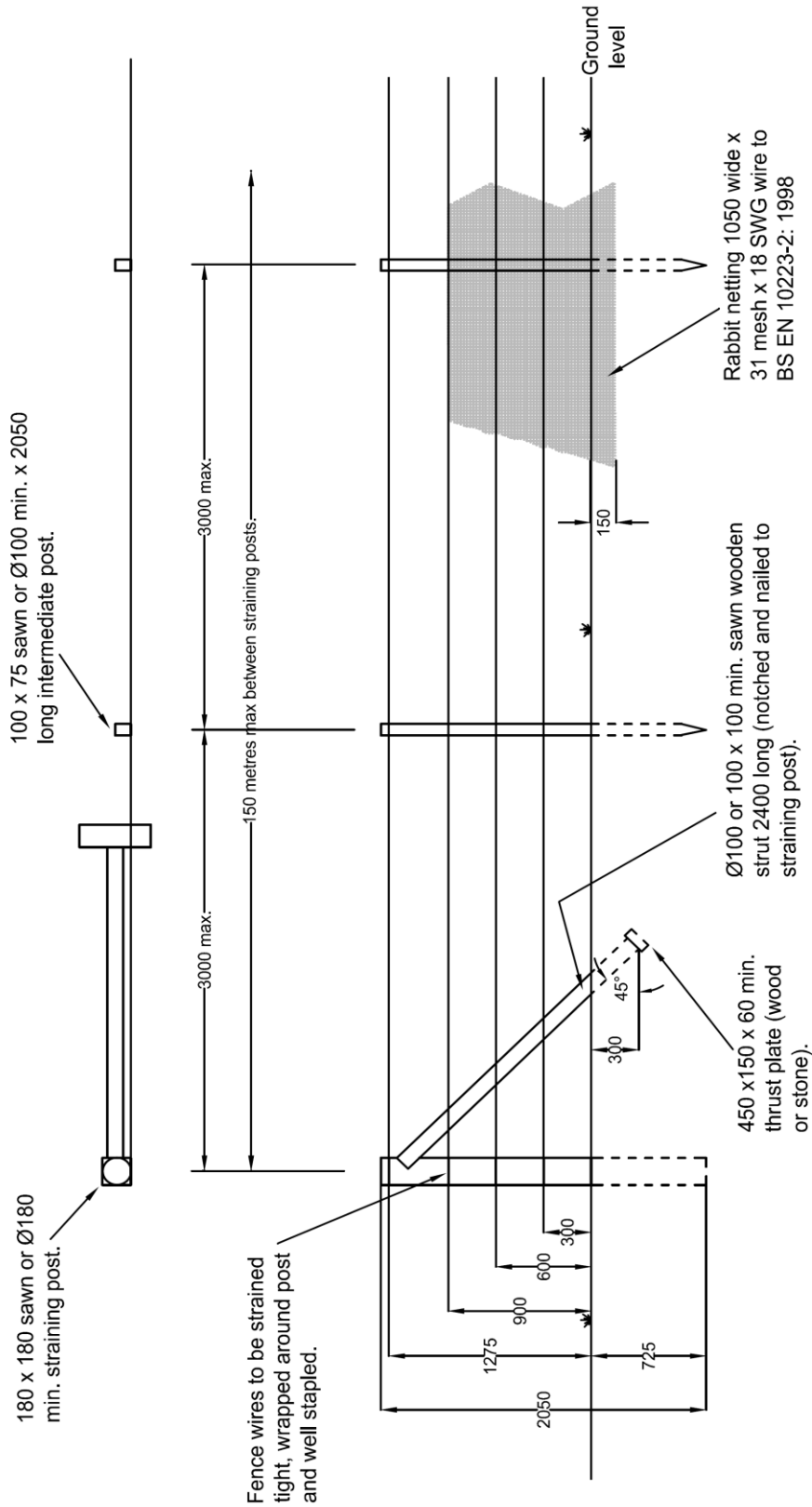

FIGURE 4 - Temporary access gate



NOTES

1. All dimensions in mm, unless stated otherwise.
2. Wire to be to BS 4102, galvanised to BS EN 10244-2: 2001.
3. Straining post must be set in concrete.
4. Gauge of wire to be:
 - a) High tensile plain 12SWG (2.64) or 1050 mm², or
 - b) Mild steel 8SWG (4.06).
5. Staples to be 40 long.

FIGURE 5 - Strained plain wire fence for use at roadsides

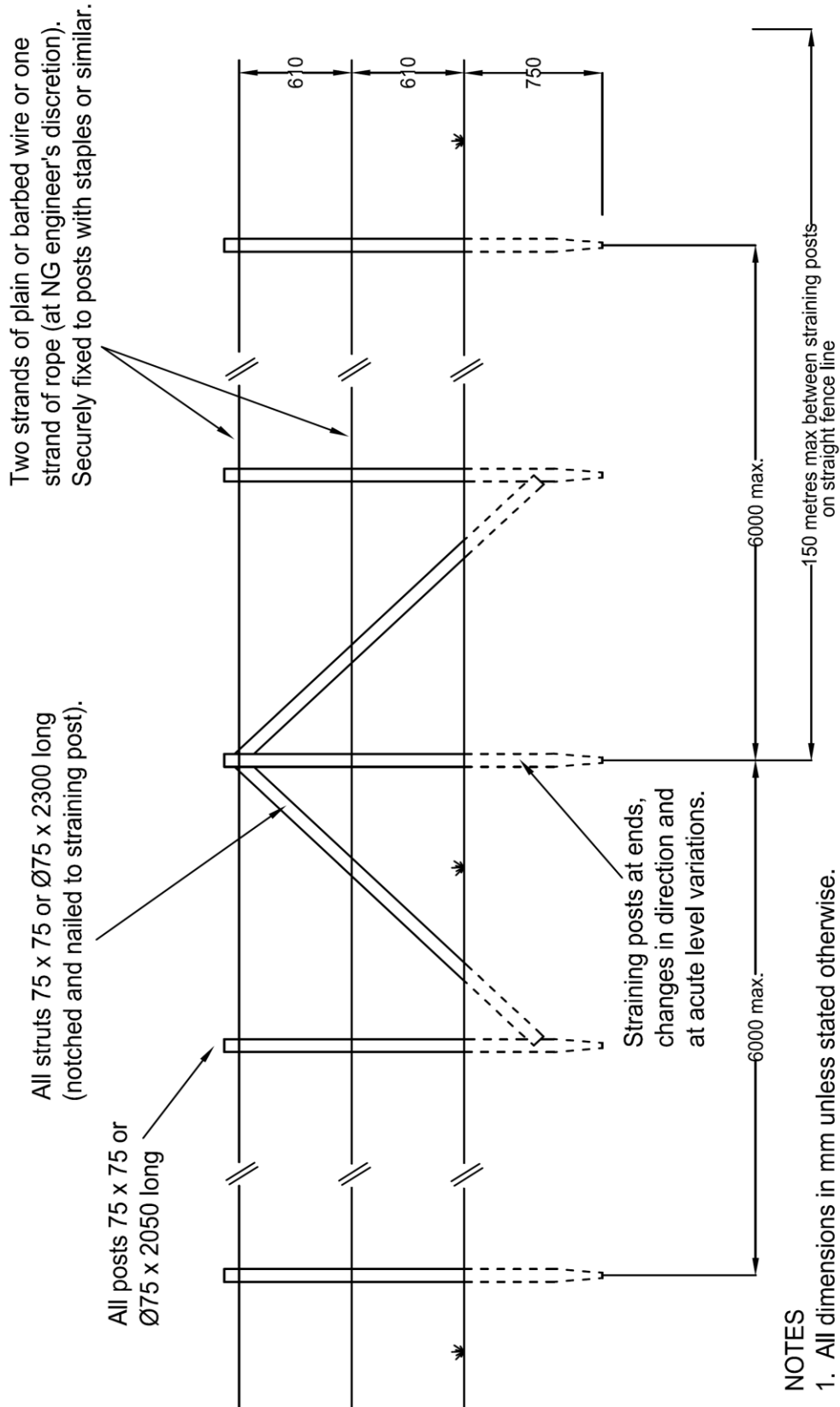

- NOTES**
1. All dimensions in mm unless stated otherwise.
 2. Wire to be to BS 4102, galvanised to BS EN 10244-2: 2001
 3. Barbed wire to be 2-ply with 4-point barbs, high tensile 14SWG (2.03).
 4. Plain wire to be mild steel 8SWG (4.06).
 5. Staples to be 40 long.

Figure 6 - Typical right of way demarcation fencing where no stock is to be contained

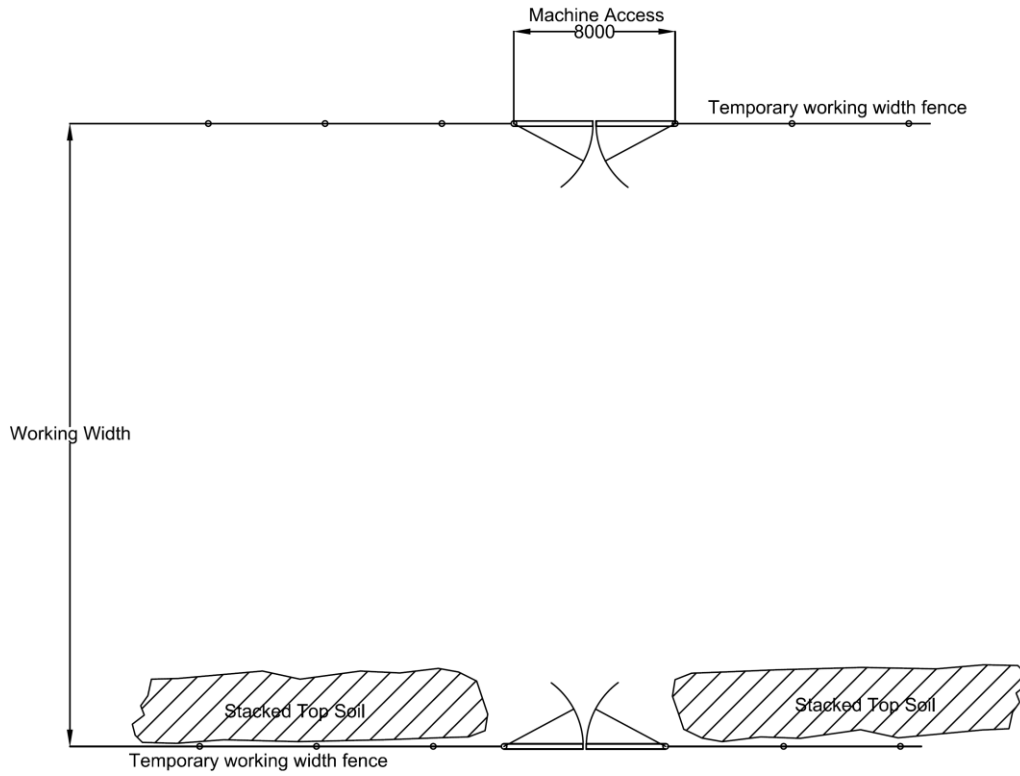

NOTE - All dimensions in mm.

Figure 7 - Machine access in temporary working width fencing

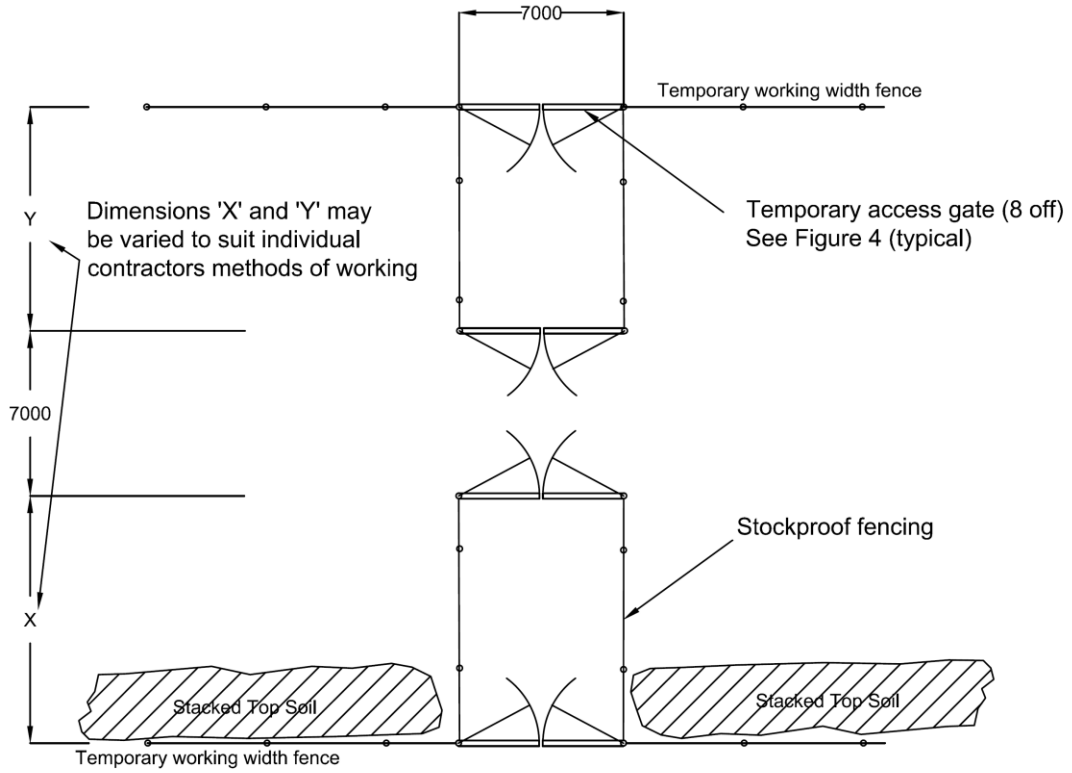

NOTE - All dimensions in mm.

FIGURE 8 - Stock access in temporary working width fencing

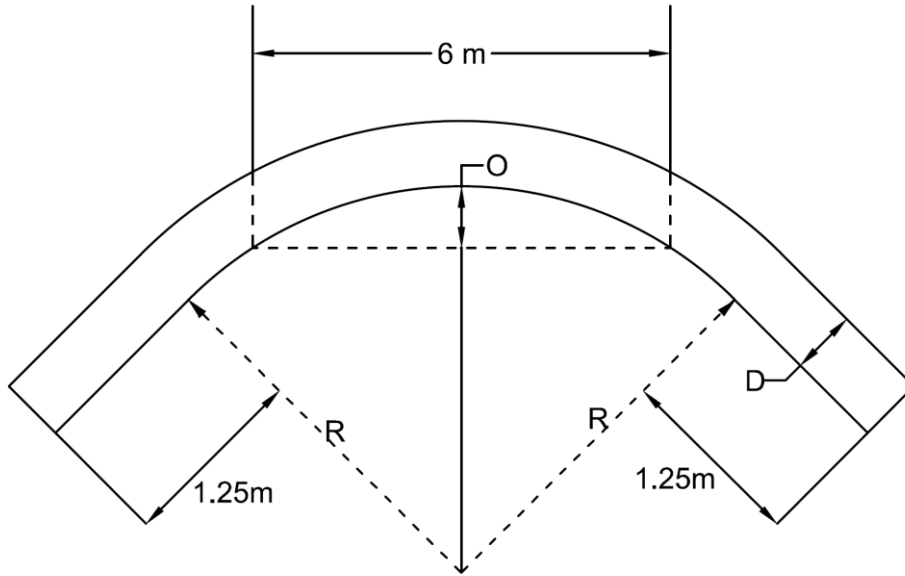

Pipe outside diameter D mm	114.3	168.3	219.1	273	323.8	356	406.4	457.2	508	559	609.6	762	914.4	1066.8	1219
Minimum radius R m	4.57	6.73	8.76	10.92	12.95	14.24	16.26	18.29	20.32	22.36	24.38	30.48	36.58	42.67	48.76
Middle ordinate O mm	1120	710	530	430	360	320	280	250	230	210	190	150	130	110	100

Figure 9a - Form of cold bend with values for minimum radius and permissible middle ordinate for various sizes of pipe

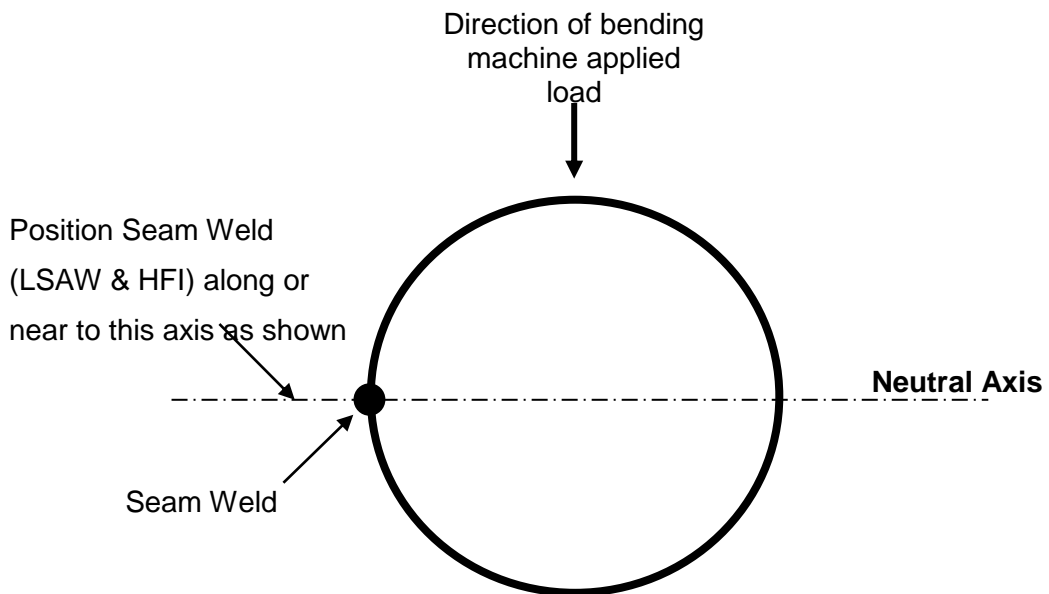

Figure 9b - Position of seam weld during cold bending procedures

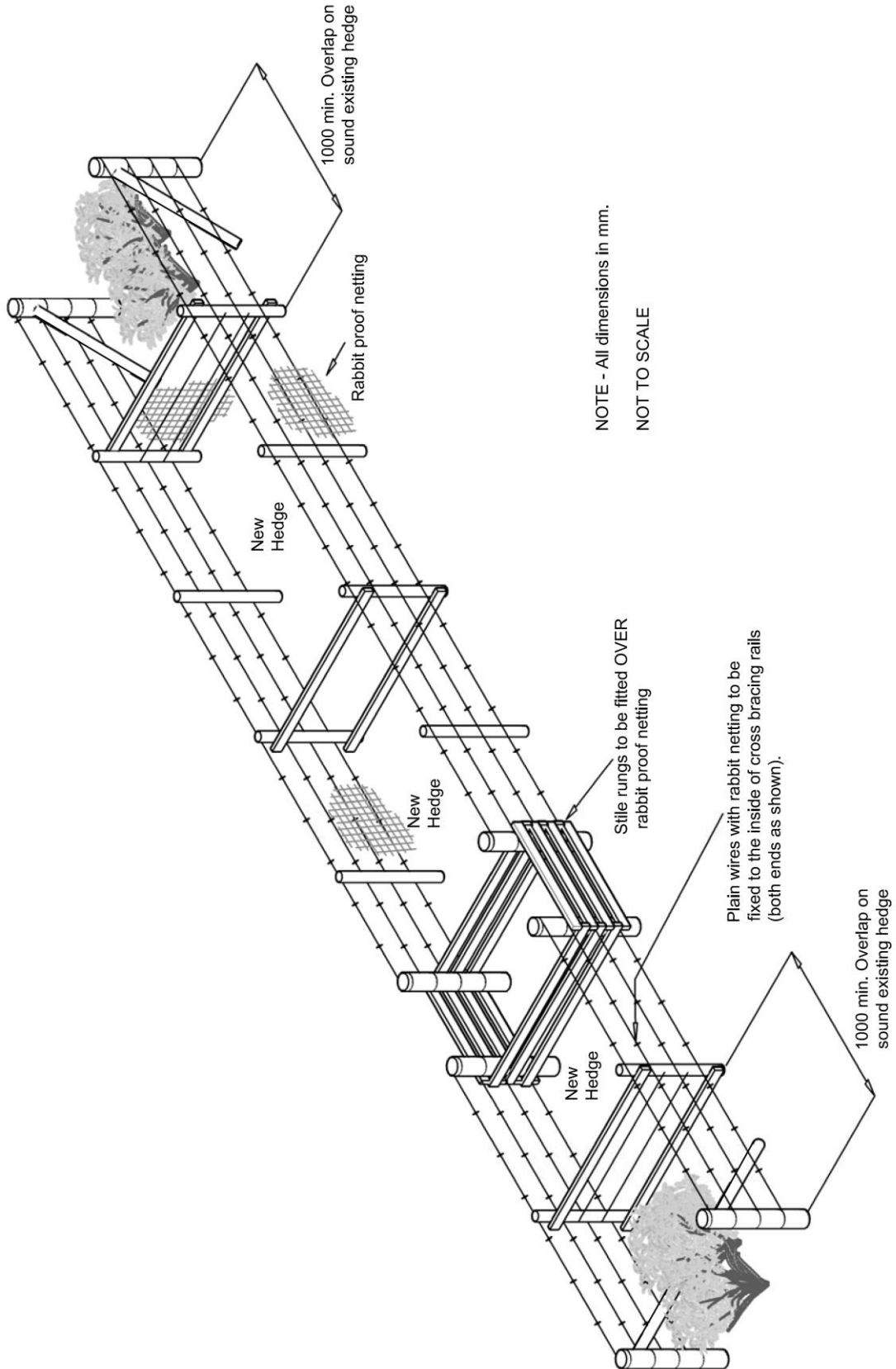

Figure 10 - Typical fencing to protect new hedging material where stock is present

Particular Requirements for Figure 10**1. Timber**

- 1.1 A timber should be tannalized softwood preserved to BS 8417.
- 1.2 Intermediate posts should be 100 mm x 100 mm sawn, or 100 mm diameter.
- 1.3 Stile rails should be 100 mm x 40 mm sawn.

2. Ironmongery

- 2.1 All wire should be to BS 4102, galvanized to BS EN 10244-2.
- 2.2 Barbed wire should comply with BS EN 10223-1 and be two-ply with four-point barbs. However, where horses occupy adjacent land, plain in accordance with 2.3 a) should be used.
- 2.3 Gauge of wire should be as follows:
 - a) Plain wire - 10 SWG (3.15 mm diameter) high tensile drawn carbon steel.
 - b) Barbed wire- 12 SWG (2.5 mm diameter) mild steel min tensile strength 350 N/mm²
- 2.4 Wire staples should be 40 mm long.
- 2.5 Butterfly tensioners should be used on each strand of wire.

3. Concrete

Concrete should be in accordance with table 2 of GD/SP/CE/2.

4. Hedging

On arable land with no stock, a fence (to protect hedging) incorporating three strands of plain wire and rabbit netting is acceptable.

5. Erection

- 5.1 Straining posts should be set in 400 mm square concrete to within 300 mm of the finished ground level.
- 5.2 The height of the new fence should match the height of the existing hedge or fence if the latter is less than 1160 mm high.
- 5.3 Rabbit netting should be fixed, using saddle rings, to the plain wire; this should be outside of the fence generally.

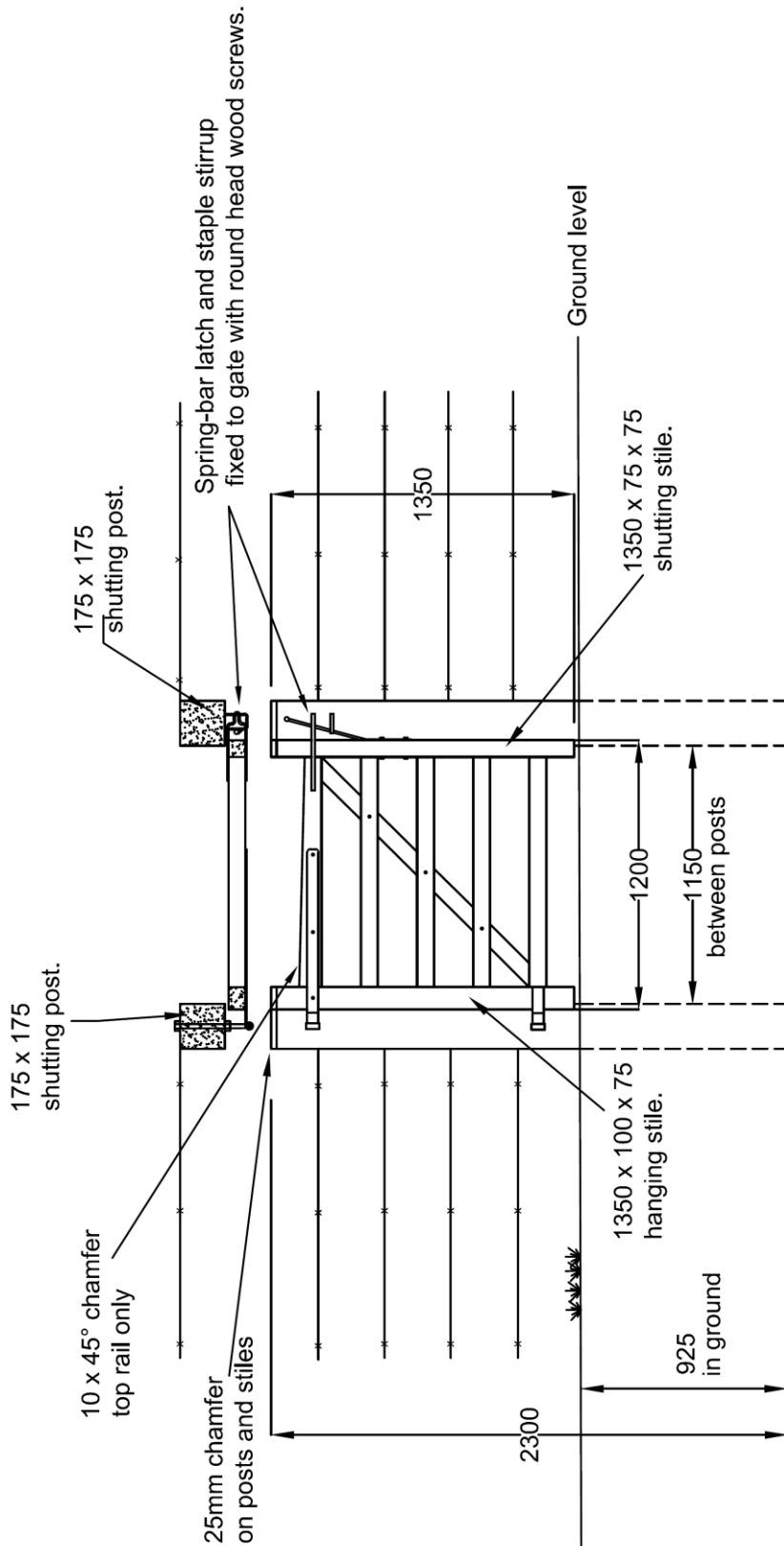

NOTES

1. All dimensions in mm.
2. Gate to be standard proprietary item, manufactured to BS3470
3. Gate to be erected to open into site.

Figure 11 - Standard gate for 1200 mm access in post and wire fence

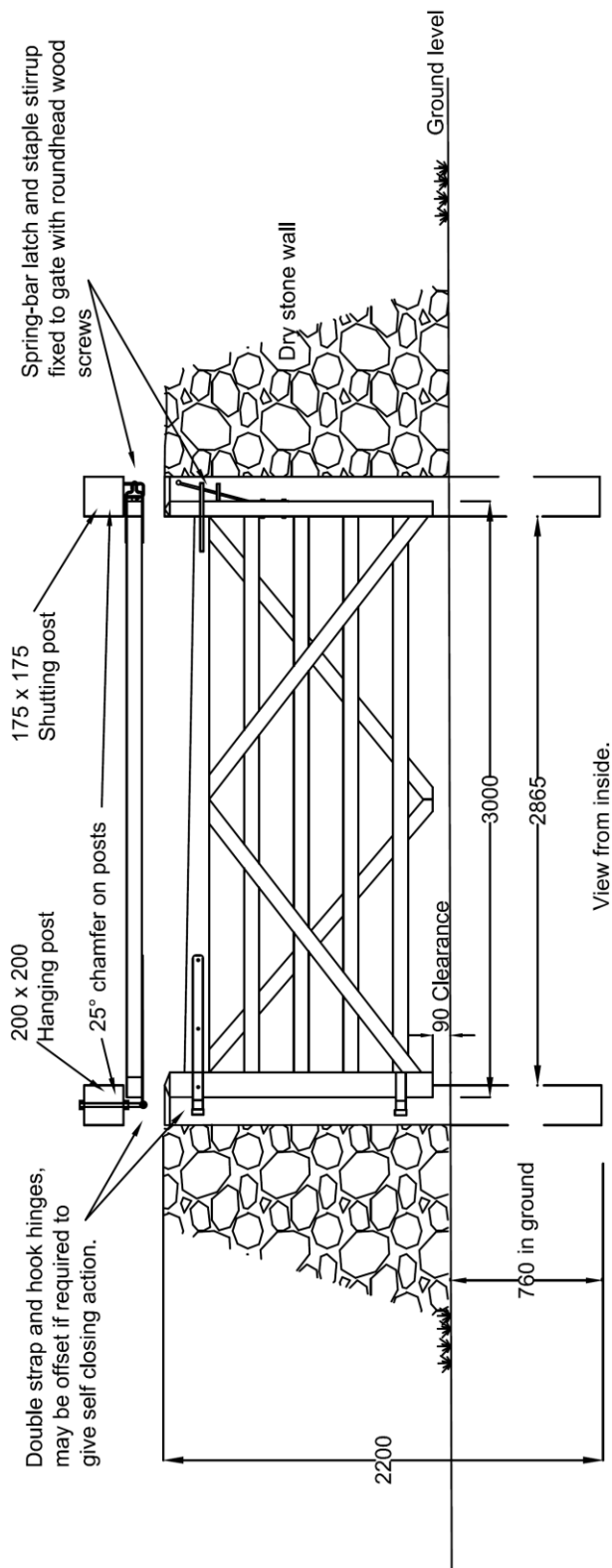

Diamond braced field gate specification.

- Heel : 1350 x 125 x 75
- Head : 1350 x 75 x 75
- Top bar tapers : 125 x 75 to 75 x 75
- Rails and braces : 75 x 75
- Top bar and fourth rail morticed right through and pegged.
- Braces let into underside of top bar.
- All crossing timbers bolted with sheradized or galvanised bolts.

NOTES

1. All dimensions in mm.
2. Gate to be standard proprietary item, manufactured to BS3470

Figure 12 - Standard gate for 3000 mm access in dry stone wall

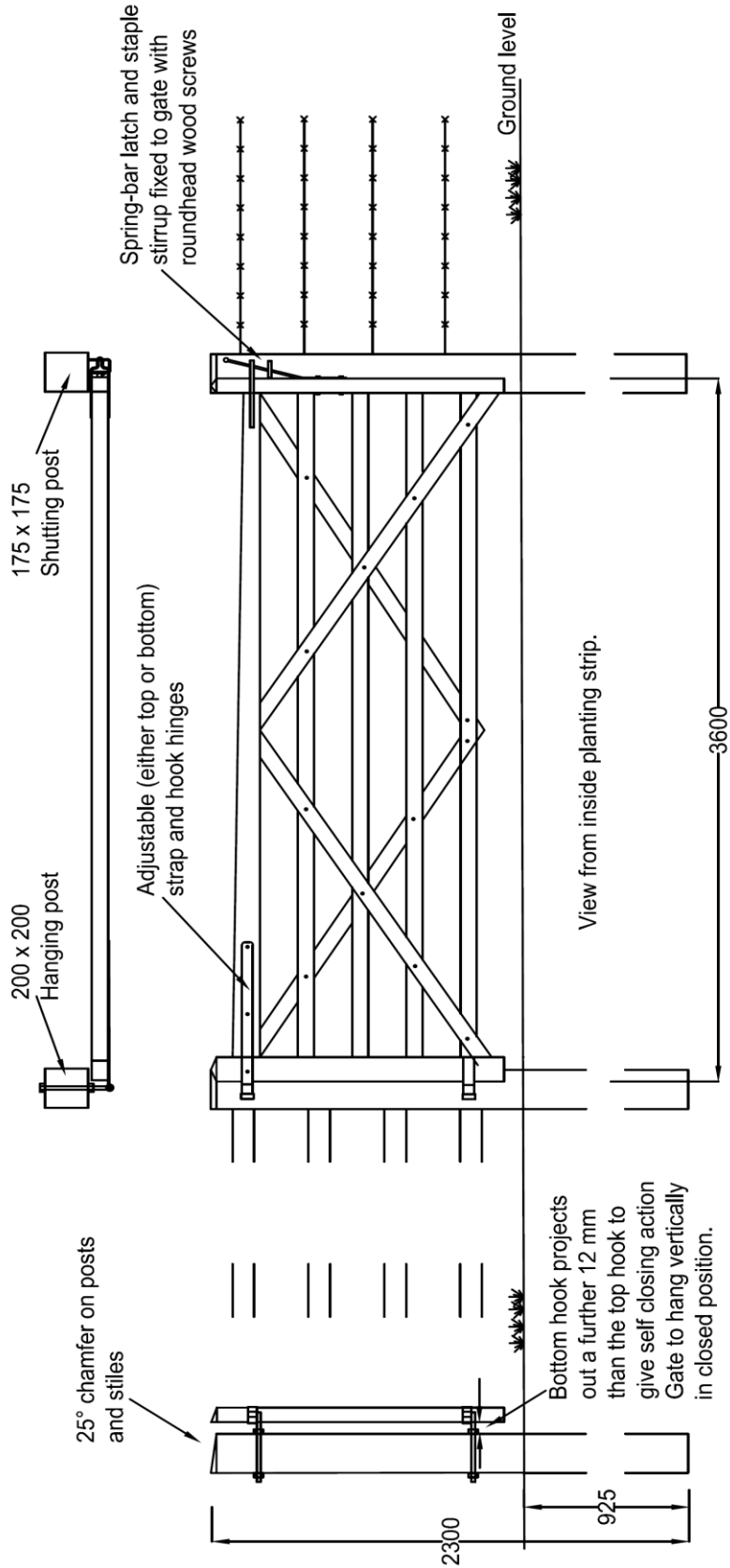

NOTES

1. All dimensions in mm.
2. Gate to be standard proprietary item, manufactured to BS3470
3. Gate to be erected to open into site.

Figure 13 - Standard gate for 3500 mm access in post and rail or post and wire fence for fields or hard-core roads

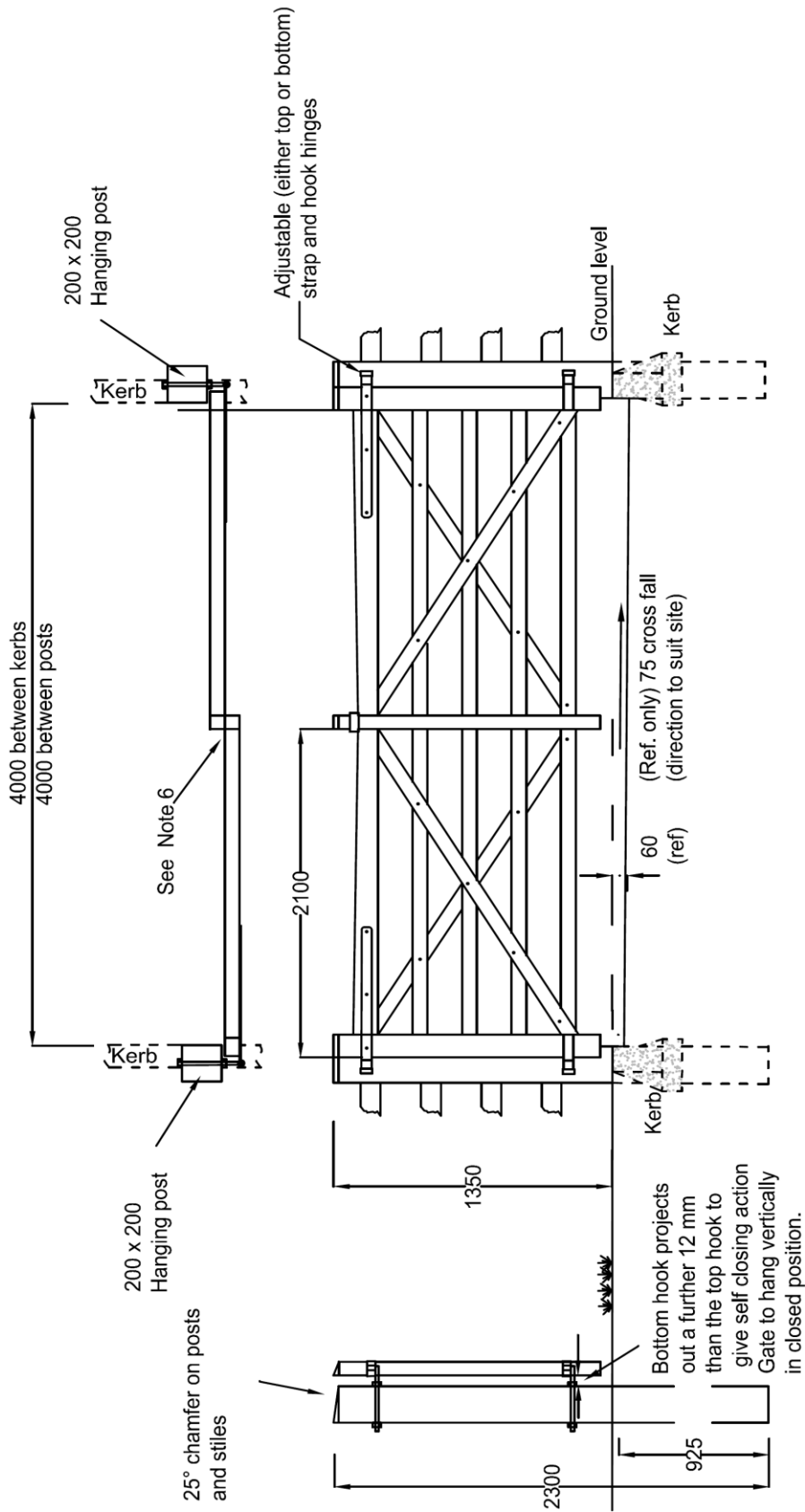
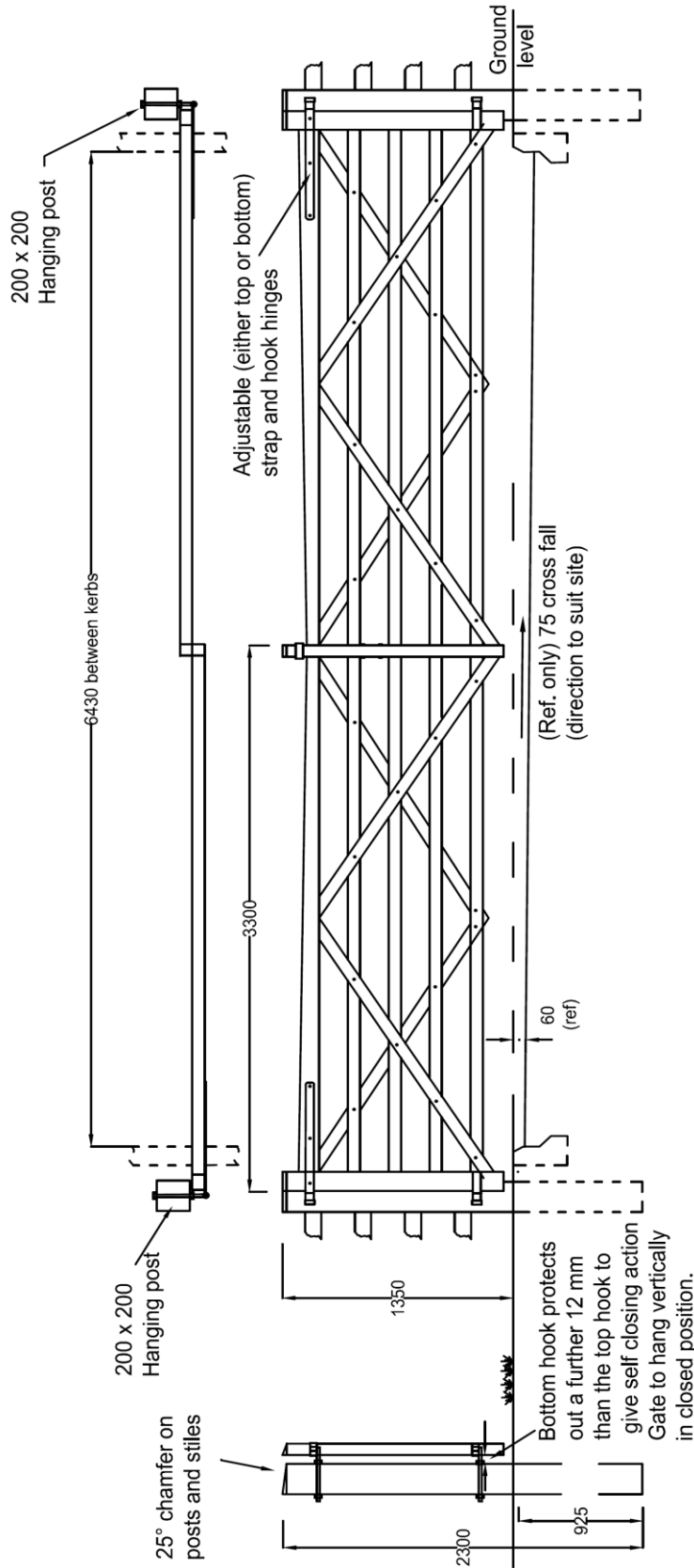

Figure 14 - Standard gate for 4000 mm access in post and rail fence

NOTES

1. All dimensions in mm.
2. Gate to be standard proprietary item, manufactured to BS3470
3. Gate to be erected to open into site.
4. Hold-back catches to be installed to retain gates in the open position.
5. Gates to be secured with chain and padlock (National Grid supply).
6. 6 thick x 45 wide mild steel stirrup, bent to suit, fixed to shutting stile with M6 roundhead bolt 100 long complete with hex. nut. Peen bolt head after assembly.



NOTES

1. All dimensions in mm.
2. Gate to be standard proprietary item, manufactured to BS3470
3. Gate to be erected to open into site.
4. Hold-back catches to be installed to retain gates in the open position.
5. Gates to be secured with chain and padlock (National Grid supply).

Figure 15 - Standard gate for 6000 mm access in post and rail fence

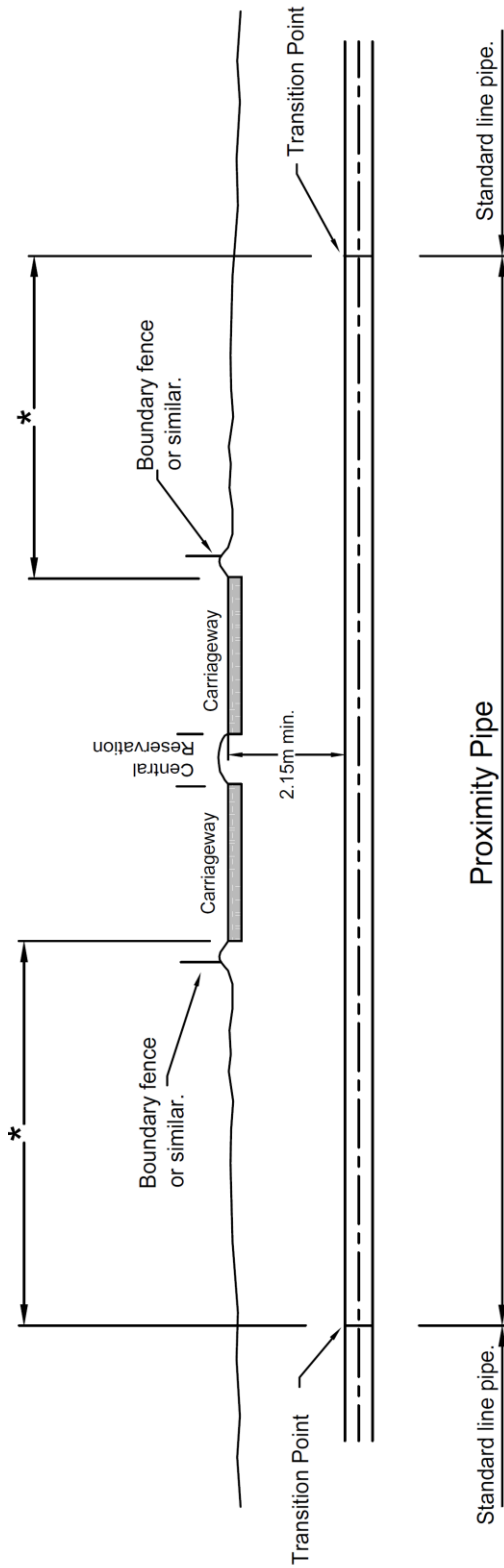

* Proximity distance in accordance with IGEM/TD/1 or 5 metres from the boundary fence, whichever is greater.

Figure 16 - High density traffic route crossing

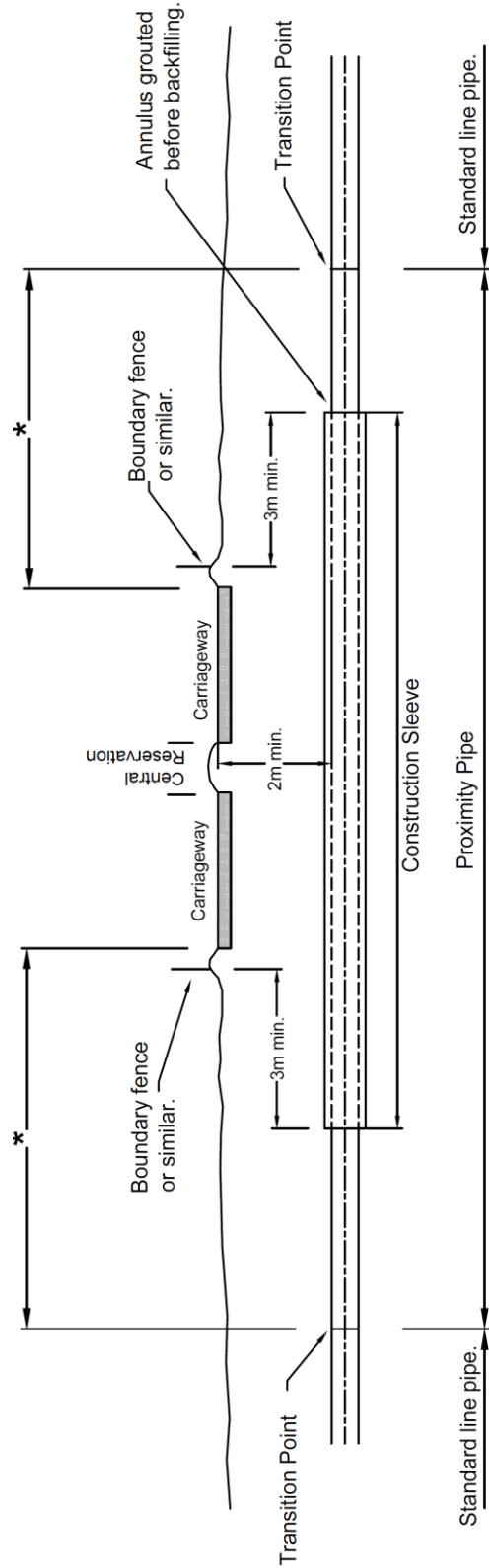

* Proximity distance in accordance with IGEM/TD/1 or 5 metres from the boundary fence, whichever is greater.

Figure 17 - High density traffic route sleeved crossing

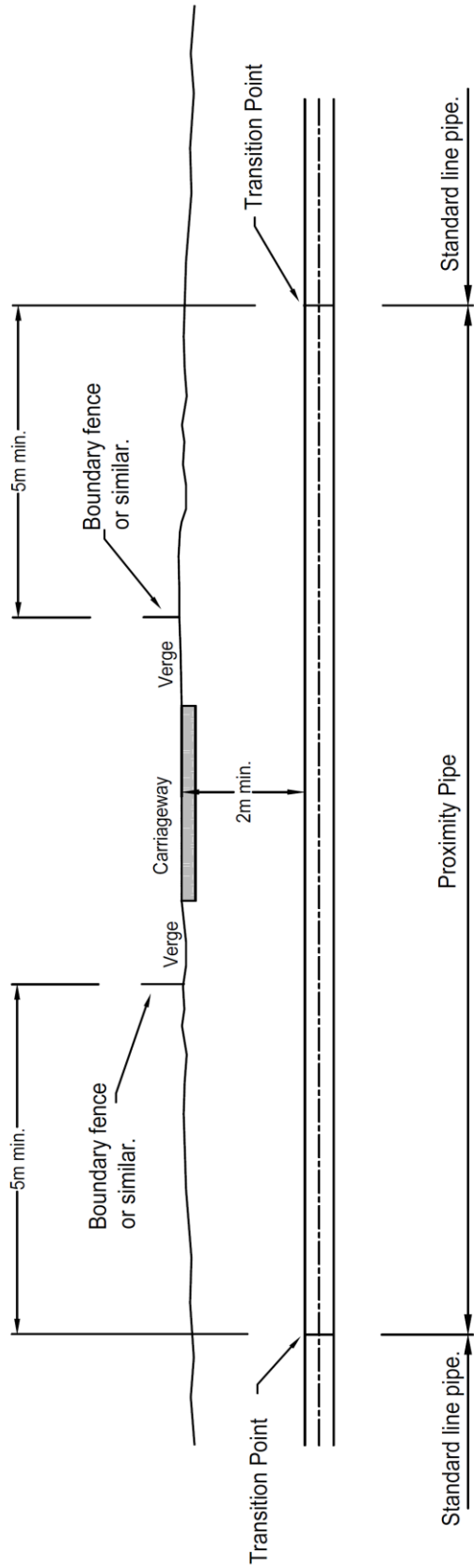

Figure 18 - Other traffic route crossing

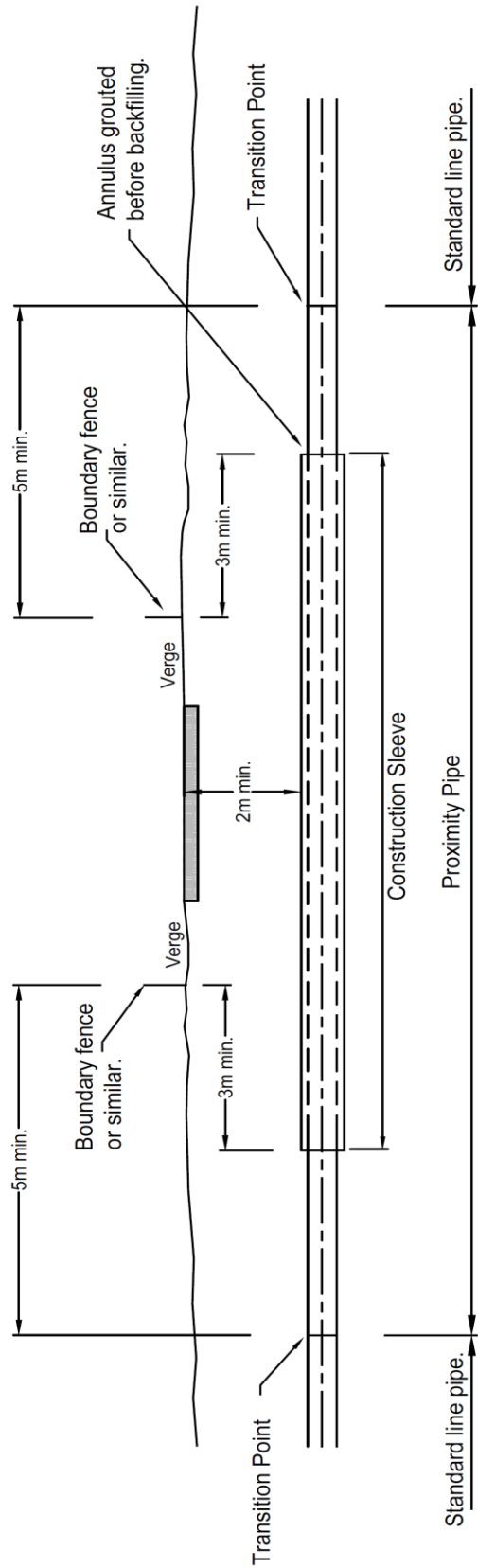
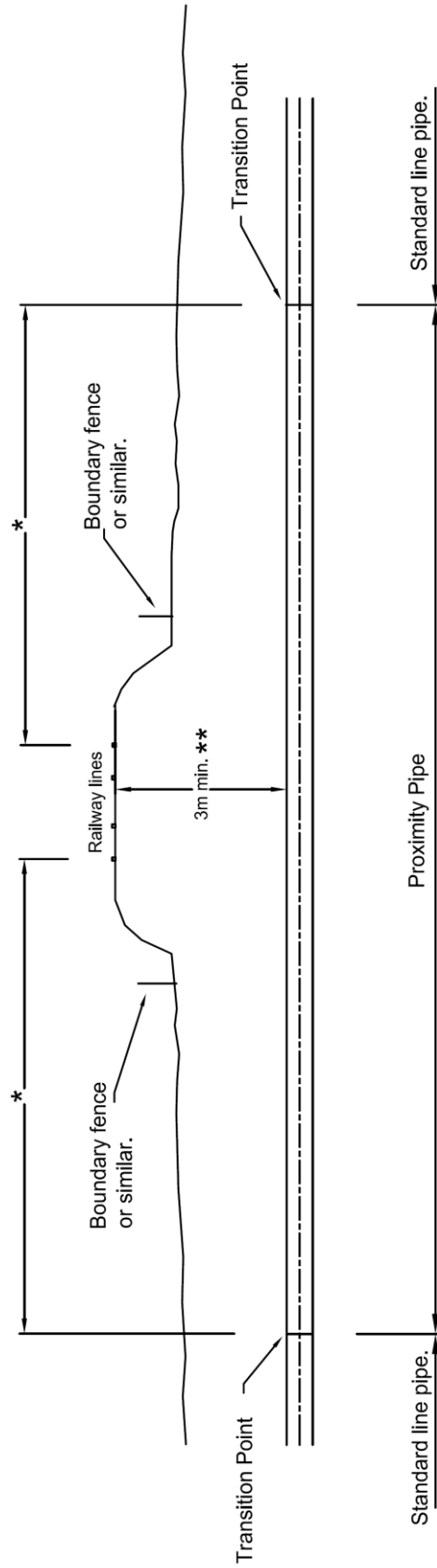
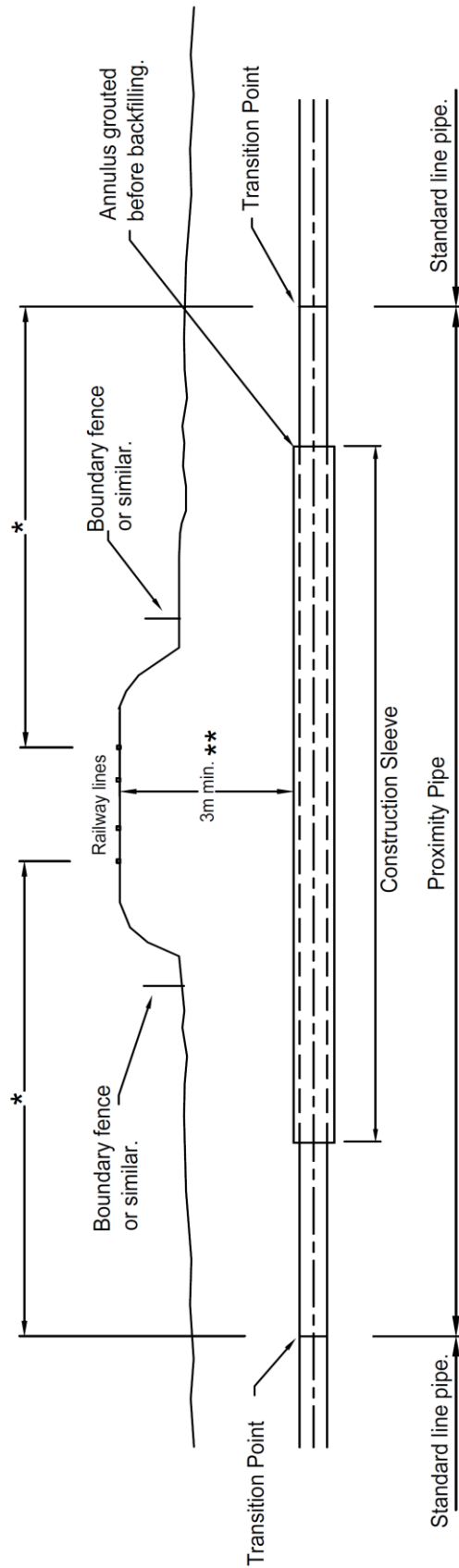

Figure 19 - Other traffic route sleeved crossing



* Proximity distance in accordance with IGEM/TD/1 or 5 metres min. from the boundary fence whichever is greater
** To be determined in conjunction with Rail Authority.

Figure 20 - Railway crossing



* Proximity distance in accordance with IGEM/TD/1 or 5 metres from the boundary fence whichever is greater
 ** To be determined in conjunction with Rail Authority.

Figure 21 - Sleeved railway crossing

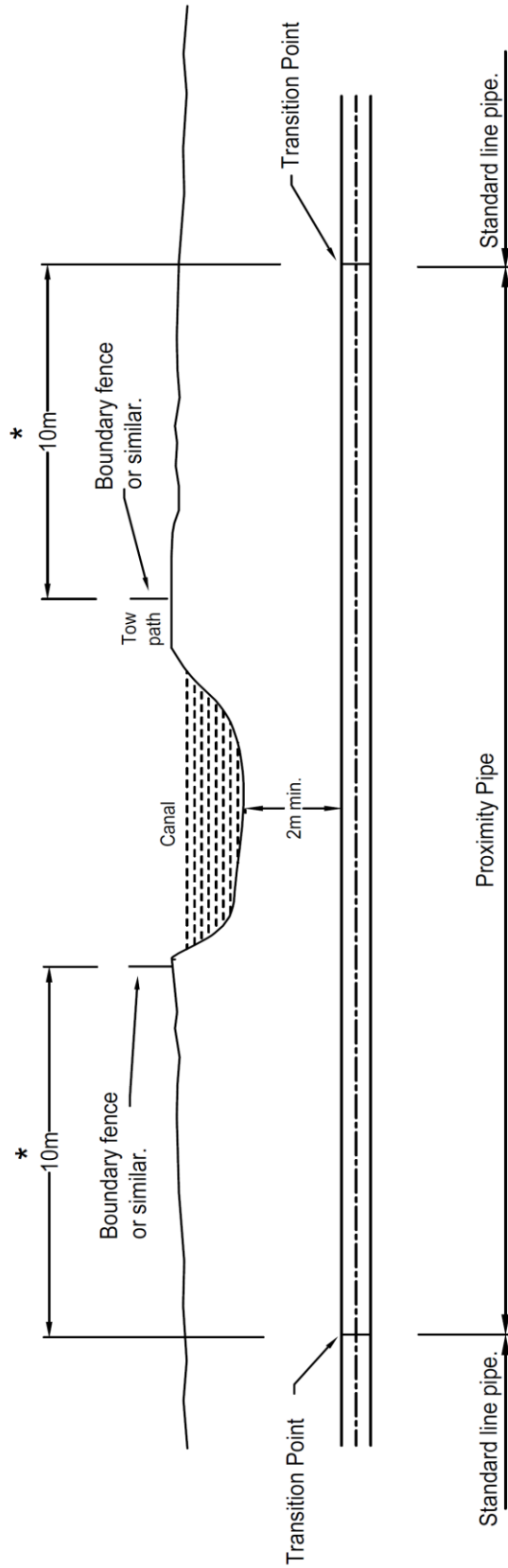

* To be determined in conjunction with Waterways Authority.

Figure 22 - Canal crossing

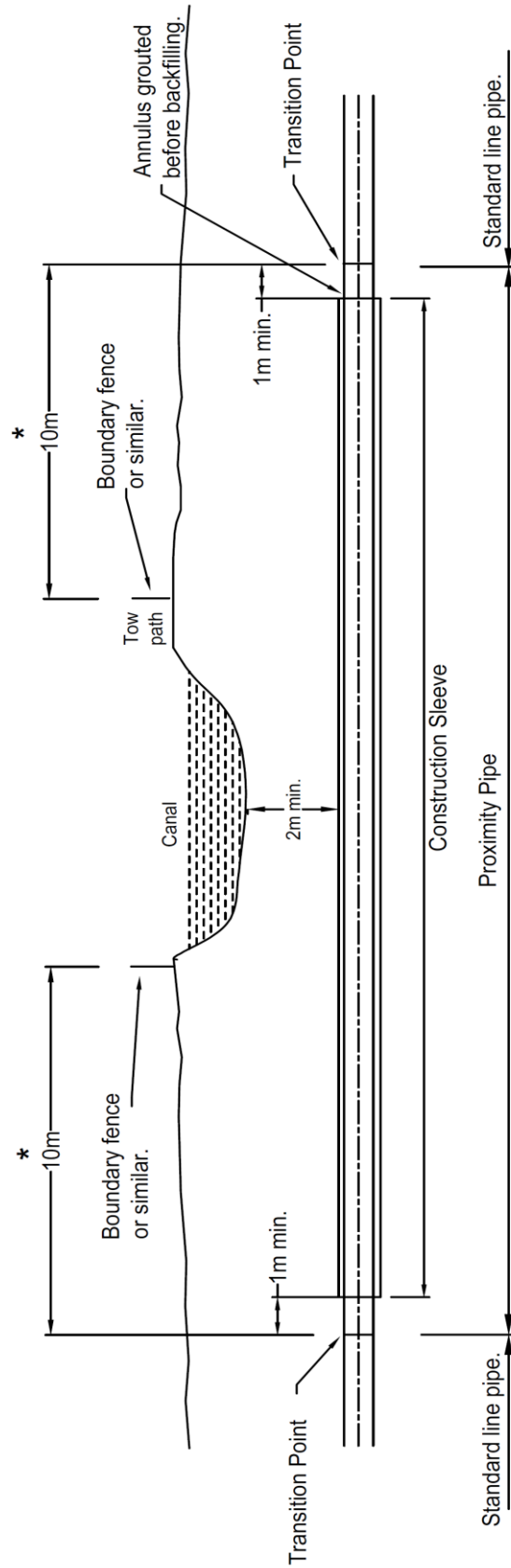

* To be determined in conjunction with Waterways Authority.

Figure 23 - Sleeved canal crossing

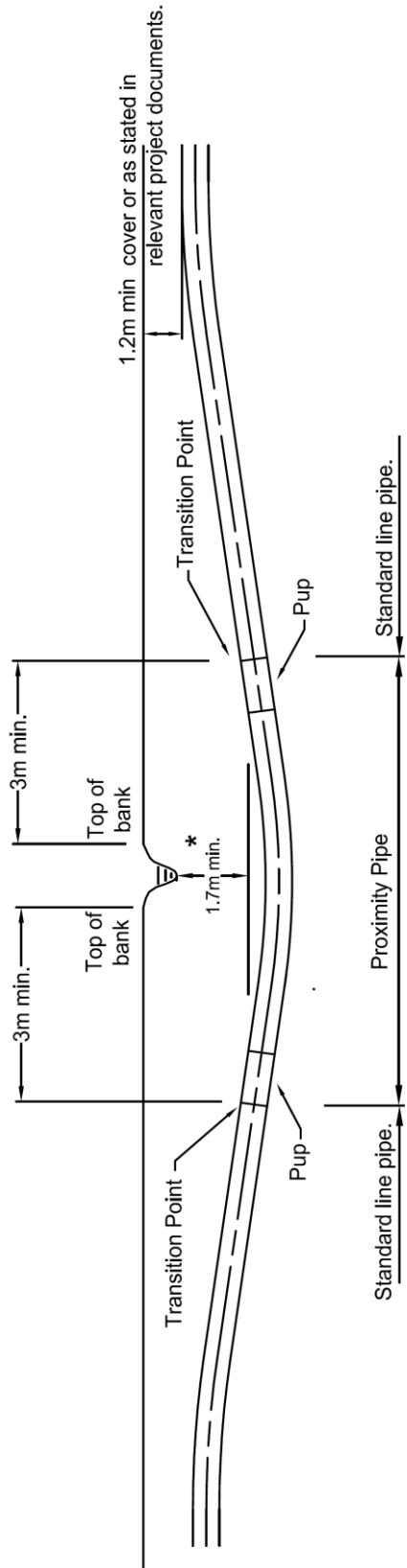

* Minimum depth may be increased due to water authority operating requirements, and should apply to the full width of the proximity pipe.

Figure 24 - Minor ditch or stream crossing

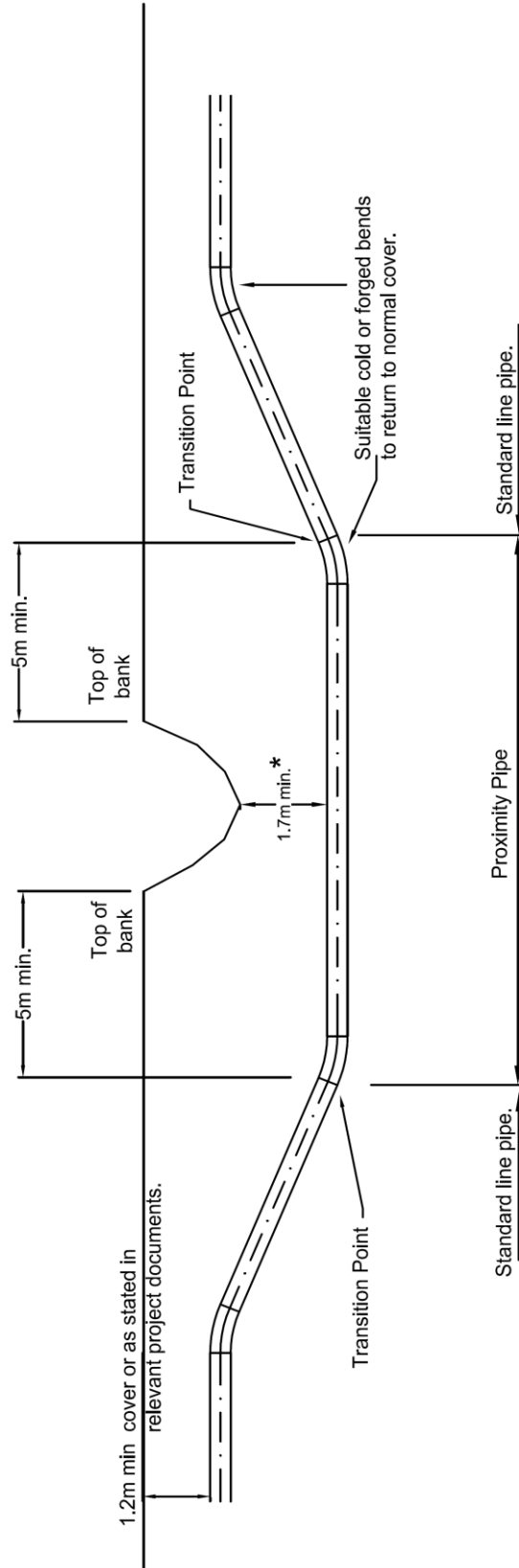

* Minimum depth may be increased due to water authority operating requirements. For river crossings the minimum depth shall be 2m.

Note : The proximity pipe may need to be extended up the riser in order to accommodate additional loading due to depth. Reference should be made to T/SP/GM/1.

Figure 25 - Major ditch or stream crossing

APPENDIX A**References**

	British Standards
BS 8417	Preservation of Wood – Code of Practice
BS 4102	Specification for Steel Wire for General Fencing Purposes
BS 5911	Precast concrete pipes, Fittings and Ancillary Products
BS EN 10223	Steel Wire and Wire Products for Fencing
BS EN 10223-1	Zinc and Zinc Alloy Coated Steel Barbed Wire
BS EN 10223-2	Hexagonal Steel Wire for Agricultural, Insulation and Fencing Purposes
BS EN 10244-2	Steel wire and wire Products – Non-ferrous Metallic Coatings on Steel wire Part 2: Zinc or Zinc alloy Coatings
BS 3470	Specification for Field Gates and Posts
	Statutes and Regulations
	New Roads and Streetworks Act 1991
	Public Gas Transporters Pipeline Works (Environmental Effects) Regulations 1999)
	Construction (Design & Management Regulations) 2007 (CDM2007)
	International Standards
ISO 14001	Environmental Management Systems
	Health & Safety Executive
GS6	Avoidance of Danger from Overhead Electric Lines
HS(G)47	Avoiding Danger from Underground Services
	Highway Authority and Utilities Committee (HAUC)
	Specification for the Reinstatement of Openings in Highways
	Institution of Gas Engineers and Managers
IGEM/TD/1 Edn 5	Steel Pipelines and Associated Installations for High Pressure Gas Transmission
IGEM/TD/1 Edn 5 Supplement 1	Handling, Transport and Storage of Steel Pipe, Bends and
IGEM/TD/3 Edn 4	Steel and PE Pipelines for Gas Distribution
	Internal Specifications
GD/SP/CE/2	Specification for the Design, Construction and testing of Civil and Structural Works - Geotechnical, Ground Works and Foundations
GD/SP/CE/12	Specification for the Design, Construction and testing of Civil and Structural Works – Part Twelve: Protection works over Steel Pipelines
GD/SP/CW/5	Specification for Field Applied External Coatings for Buried Pipework and Systems
GD/SP/CW/6	Technical Specification for the External Protection of Steel Line Pipe and Fittings Using Fusion Bonded Powder and Associated Coating Systems: Part 1 - Requirements for Coating Materials and Methods of Test Part 2 - Factory Applied Coatings
GD/SP/CW/9	Technical Specification for Concrete Coating of Pipes Part 1 - Negative Buoyancy Coatings

	Part 2 - Security Coatings Part 3 - Thrust Boring Coatings
GD/PL/ECP/1	Policy for Corrosion Control of Buried Steel Systems
GD/PM/ECP/1	Management Procedure for Cathodic Protection of Buried Steel
GD/SP/ECP/4	Specification for Direct Current Voltage Gradient Survey
GD/SP/ECP/5	Specification for undertaking Electromagnetic Current Attenuation (ECA) surveys
GD/SP/ECP/6	Specification for Close Interval Potential Surveys
GD/SP/F/6	Technical Specification for Carbon and Carbon Manganese Steel Pipe Pups for Operating Pressures Greater than 7 barg
GD/SP/LAN/1	Technical Specification for Landscape Works
GD/PM/LAN/2	Management Procedures for Maintenance of Landscaped Sites
GD/SP/NDT/2	Specification for Non-Destructive Testing of Welded Joints in Steel Pipelines and Pipework
GD/SP/PA/9	Technical specification for paint systems - properties and performance requirements.
GD/SP/PA/10	Technical specification for new and maintenance painting at works and site for above ground pipeline and plant installations.
GD/SP/P/2	Specification for Welding of Steel Land Pipelines and Installations Designed to Operate at Pressures greater than 7 barg. (Supplementary to BS 4515-1)
GD/SP/P/8	Specification for the welding of steel onshore natural gas installations designed to operate at pressures greater than 7 barg.
GD/PM/P/11	Management Procedure for Inspection, assessment and repair of damaged (non-leaking) steel pipelines above 150 mm nominal diameter and designed to operate at pressures greater than 2 barg
GD/SP/P/16	Specification for the Dimensions and Applications of Standard Weld End Preparations for Steel Pipe, Fittings, Valves and Pipe Pups
GD/PM/PT/1	Management Procedure for Pressure testing pipework, pipelines, Small Bore pipework and above ground austenitic Stainless Steel Pipework
GD/PM/DP/1	Management Procedure for the Prevention of Damage to Cadent's Network
GD/SP/SSW/22	Specification for Safe Working in the Vicinity of Cadent Assets – Requirements for Third Parties
GD/SP/TR/18	Specification for Engineering of Pipelines and installations Operating at above 7barg
GD/SP/E/55	Specification for Bolting, Jointing, Threading and Fasteners for Pressures >7 barg
GD/SP/TR/21	Specification for Feasibility Studies for Pipelines and Installations Operating at above 7 barg
GD/SP/TR/22	Specification for the Environmental Statement for Pipelines and Installations Operating at above 7 barg
GD/SP/TR/23	Specification for the Conceptual Design of Pipelines and installations Operating at above 7 barg
GD/SP/TR/24	Specification for Detailed Designs of Pipelines and Installations Operating at above 7 barg
GD/PM/SHES/81	Safety, Health and Environmental of Projects (CDM) Standard
GD/PM/TR/39	Risk Assessment and Management of Unexploded Ordnance
GD/SP/E/56	Specifications for Ancillary Pipeline Equipment
GDN/PM/SCO/1	Management Procedure for Safe Control of Operations
GD/SP/TR/29	Specification for Marker Posts to be Used for Above 7 Bar(g) Pipelines

GD/PM/TR/28	Management Procedure for the Siting and Installation of Marker Posts for Pipelines Operating Above 7 barg
GD/PM/PSR/4	Management Procedure for Ensuring Compliance with the Pipelines Safety Regulations 1996
GD/PM/GR/2	Management Procedure for The Management of Cadent Engineering Standards
	Other Specifications
LDCA	Land Drainage Contractors Association Technical Note for Drainage Schemes.
CIRIA C648	Control of Water Pollution from Linear Construction Projects

APPENDIX B**Definitions**

Cultivated land	Any land (excluding grass land or land laid down to cultivate turf) on which crops or produce of any kind are normally grown, including but not limited to agricultural land, allotments, pleasure gardens, nurseries, flower gardens and land lying fallow.
Enveloping	A backfilling technique employed to reduce the amount of imported and exported trench material.
Gauging pig	A pig used to prove the internal diameter of a pipeline. It is essentially a swabbing pig fitted with an aluminium sizing disc.
Geometric pig	A pig which measures and records the diameter and ovality of a pipeline by using sensing probes.
Header drain	A new length of land drain usually installed parallel to the pipeline on the upslope side, for the purpose of intercepting existing land drains severed by the pipeline and discharging to a suitable outfall. The header drain may also function as an interceptor of groundwater throughout its length. The design function shall influence whether or not permeable backfill is advocated. A header drain may also be referred to as a 'cut-off', 'interceptor' or 'connector' drain.
Installation	The fabricated assemblies of pipes, fittings and equipment above and below ground, normally situated within a fenced enclosure.
Legislation	All statutes, statutory instruments, by-laws, regulations and directives which are relevant to the Works.
Magnetic cleaning pig	A pig for removing ferrous debris from the bore of a pipeline.
Main Works Contractor	The contractor with whom the Company enters into a contract for the pipeline works
Permanent Works	Works to be constructed, completed and maintained in accordance with the Contract.
Pig	Pipeline Internal Gauge. A device inserted in and designed to travel along the inside of a pipeline which can be propelled through a pipeline by air, gas or liquid under pressure. Used for various purposes (e.g. cleaning, swabbing, inspection).
Pipeline	All pipes forming part of the Works including cut pipes, bends, tees, valves and other fittings.
Pup	A short make-up piece of pipe.
Site	The lands and other places on, under, in or through which the Works are to be executed.
Swabbing pig	A pig for removing liquids from the bore of a pipeline and also for separating slugs (e.g. methanol from gas).
Trench width	For pipe up to but not greater than 900 mm diameter, the nominal trench width should be the outside diameter of the pipe or sleeve plus 300 mm. For pipe greater than 900 mm size, the trench width should be the outside diameter of the pipe or sleeve plus 600 mm.
Working width	The area between the temporary fences within which all the Works in connection with the pipeline and installation are to be carried out.

Cadent
Ashbrook Court
Prologis Park
Central Boulevard
Coventry
CV7 8PE

Copyright Cadent Gas Limited.©, all rights reserved. No part of this publication may be reproduced in any material form (including photocopying and restoring in any medium or electronic means and whether or not transiently or incidentally) without the written permission of Cadent Gas Limited. except in accordance with the provisions of the Copyright, Designs and Patents Act 1988.

July 2020